



McIntosh Laboratory, Inc. 2 Chambers Street Binghamton, New York 13903-2699 Phone: 607-723-3512 [www.mcintoshlabs.com](http://www.mcintoshlabs.com)

MA252

Integrated Amplifier

Owner's Manual





**Important Safety Information is supplied in a separate document “Important Additional Operation Information Guide”**

**Thank You**

Your decision to own this McIntosh MA252 Integrated Amplifier ranks you at the very top among discriminating music listeners. You now have “The Best.” The McIntosh dedication to “Quality,” is assurance that you will receive many years of musical enjoyment from this unit.

Please take a short time to read the information in this manual. We want you to be as familiar as possible with all the features and functions of your new McIntosh.

**Please Take A Moment**

The serial number, purchase date and McIntosh Dealer name are important to you for possible insurance claim or future service. The spaces below have been provided for you to record that information:

Serial Number: \_\_\_\_\_

Purchase Date: \_\_\_\_\_

Dealer Name: \_\_\_\_\_

**Technical Assistance**

If at any time you have questions about your McIntosh product, contact your McIntosh Dealer who is familiar with your McIntosh equipment and any other brands that may be part of your system. If you or your Dealer wish additional help concerning a suspected problem, you can receive technical assistance for all McIntosh products at:

McIntosh Laboratory, Inc.  
2 Chambers Street  
Binghamton, New York 13903  
Phone: 607-723-3512  
Fax: 607-724-0549

**Customer Service**

If it is determined that your McIntosh product is in need of repair, you can return it to your Dealer. You can also return it to the McIntosh Laboratory Service Department. For assistance on factory repair return procedure, contact the McIntosh Service Department at:

McIntosh Laboratory, Inc.  
2 Chambers Street  
Binghamton, New York 13903  
Phone: 607-723-3515  
Fax: 607-723-1917

**Table of Contents**

Safety Instructions.....	2
(Separate Sheet).....	<b>Important Additional</b>
	<b>Operation Information Guide</b>
Thank You and Please Take a Moment .....	2
Technical Assistance and Customer Service.....	2
Table of Contents .....	2
Important Information.....	3
Unpacking the MA252 .....	4-5
General Information .....	6
Connector and Cable Information .....	6
Introduction .....	7
Performance Features .....	7
Dimensions .....	8
Installation .....	9
<b>Connections:</b>	
Rear Panel Connections.....	10
Connecting Components .....	11-12
Connecting Loudspeakers.....	13-14
<b>Remote Control and Front Panel:</b>	
Remote Control Push-buttons .....	16
How to use the Remote Control.....	17
Front Panel Displays, Controls and Jack .....	18

**Setup Mode:**

How to Operate the Setup Mode ..... 19

**Setup Functions:**

Default Settings .....	19
Firmware Version .....	19
Source Input On/Off and Renaming .....	19-21
Data Port .....	21
Remote Control Codes.....	21
IR Sensor.....	22
Power Mode .....	22
Factory Reset .....	22

**Operation:**

How to Operate the MA252 ..... 24-27

**Trim Functions:**

Balance.....	24
Trim Level.....	25
Tone Control.....	25
Bass Control.....	25
Treble Control.....	26
Information Display.....	26
Trim, Mute, Headphone Jack and Power Guard .....	26
Protection Circuitry and Microprocessor Reset.....	27
Photos.....	28-29
Specifications.....	30
Packing Instructions.....	31

---

# **IMPORTANT!**

**INSTRUCTIONS FOR REMOVAL  
OF FOAM INSERT OVER THE  
VACUUM TUBES PRIOR TO  
CONNECTING THE A.C. POWER  
SUPPLY CORD, START ON THE  
NEXT PAGE.**



**Caution:** To prevent damage to the MA252 Tubes during shipping, there is a special foam insert surrounding the Tubes of the Integrated Amplifier.

**The Foam Insert must be removed from the MA252 before connecting the AC Power Supply Cord to the integrated amplifier.**

**Failure to do so has the potential of a Fire Hazard, resulting in damage to the MA252 and the surrounding environment.**

**Follow these instructions for removal of the packing foam before connecting the AC Power Supply Cord to the MA252.**

The MA252 has no user serviceable parts, including the tubes. If repairs are needed they must be performed by an authorized McIntosh Service Agency. Follow the steps below to prepare the MA252 for operation:

1. Orient the MA252 so the Front and Top of the Integrated Amplifier is facing you. Refer to figure A.

2. Remove the Warning Sheet and save it with the Shipping Carton for possible future use. Refer to figures A and B.

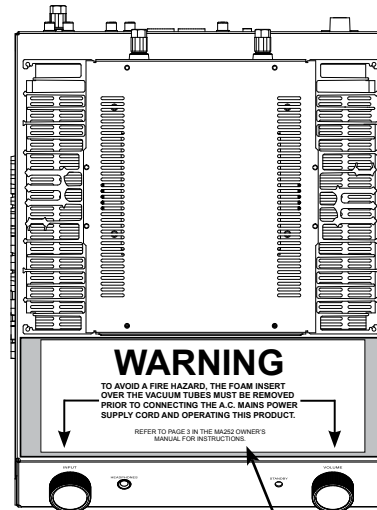

Figure A

**Remove the Warning Sheet**

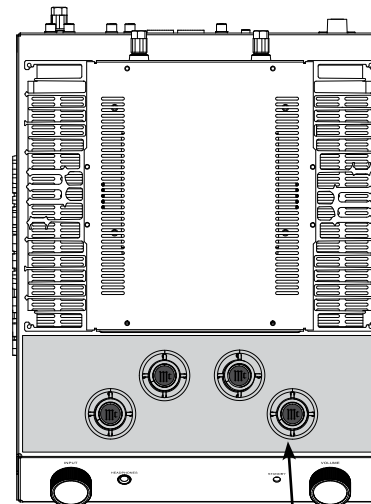

Figure B

**Vacuum Tube Shield Covers**

3. Carefully lift upright the Foam Insert Vacuum Tube Cover and place it near to the MA252 Integrated Amplifier. Refer to figure C.

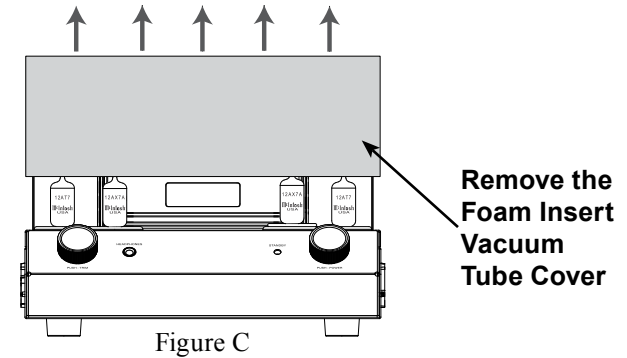

Figure C

**Remove the Foam Insert Vacuum Tube Cover**

4. Remove from the Foam, the four Vacuum Tube Shield Covers and place them along the side of the MA252 Integrated Amplifier. Save the Foam Insert Vacuum Tube Cover with the Shipping Carton for possible future use. Refer to figure D.

**Remove the four Vacuum Tube Shield Covers**

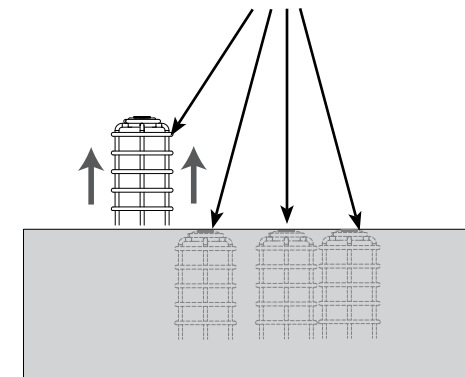

Figure D

# WARNING:

**The supplied Vacuum Tube Shield Covers must be installed over each of the four Small Vacuum Tubes before the MA252 Integrated Amplifier is connected to AC Power and activated for use!!**

**Failure to do so has the potential to cause physical harm to human beings and animals.**

**This could also result in damage to the Vacuum Tubes and the MA252 Internal Circuitry.**

**It also prevents the potential of a Fire Hazard, resulting in damage to the MA252 and the surrounding environment.**

5. The MA252 Integrated Amplifier has four Small Vacuum Tubes that are inserted into special Vacuum Tube Sockets on the Stainless Steel Chassis. Refer to figure E.

Each of the Tube Sockets have four pin openings to accept the Vacuum Tube Shield Covers. Refer to figure F.

Carefully install the Vacuum Tube Shield Covers into each of the Vacuum Tube Sockets orienting the Shield so the “Mc” on top of the Shield is facing forward. Refer to figures G and H.

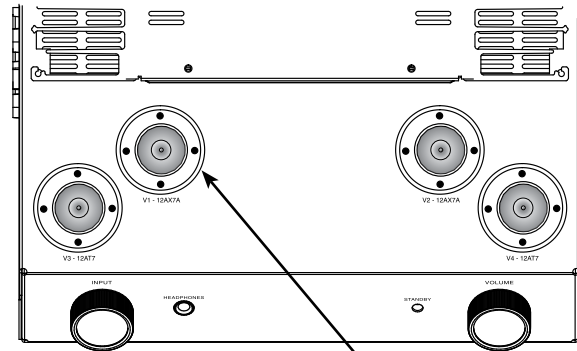

Figure E

Special Vacuum Tube Sockets

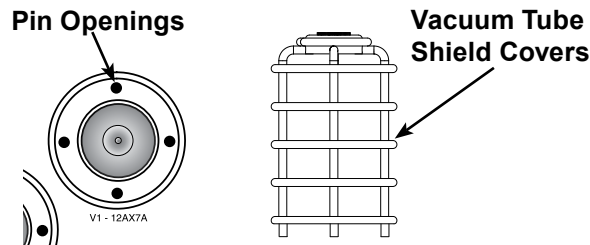

Figure F

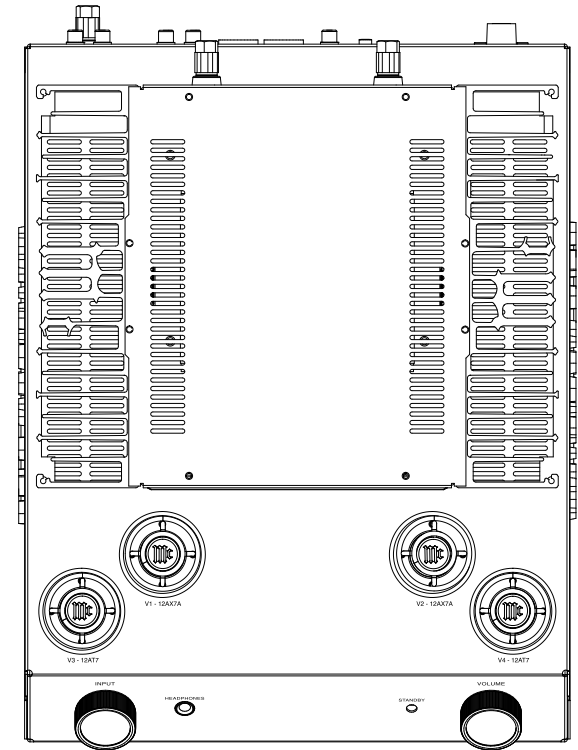

Figure G

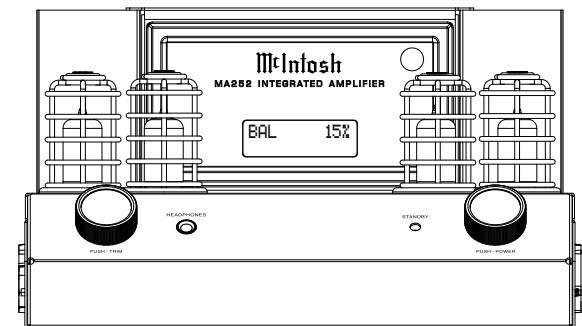



Figure H

## General Information

1. For additional connection information, refer to the owner's manual(s) for any component(s) connected to the MA252.
2. Apply AC Power to the MA252 and other McIntosh Component(s) only after all the system components are connected together. Failure to do so may cause a malfunction of system operations as the Micro-processor's Circuitry inside the components is active when AC Power is applied.
3. **The MA252 includes an Auto Off Power Save Feature and the default setting is enabled.** For additional information including how to disable it, refer to page 22.
4. When Power Amplifier Protection Circuitry of the MA252 has activated, the Vacuum Tubes LEDs are illuminated continuously with the color orange and the sound will be muted.
5. When the Power Transformer has overheated due to improper ventilation and/or high ambient operating temperature, AC Power is removed from the MA252. Normal operation will resume when the operating temperature is in a safe range again.
6. For the best performance and safety, it is important to always match the impedance of the Loudspeaker to the Power Amplifier connections. Refer to pages 10 and 11.

*Note: The impedance of a Loudspeaker actually varies as the Loudspeaker reproduces different frequencies. As a result, the nominal impedance rating of the Loudspeaker (usually measured at a midrange frequency) might not always agree with the impedance of the Loudspeaker at low frequencies where the greatest amount of power is required. Contact the Loudspeaker Manufacturer for additional information about the actual impedance of the Loudspeaker before connecting it to the McIntosh MA252.*

7. The MA252 Remote Control is capable of operating other components. For additional information go to [www.mcintoshlabs.com](http://www.mcintoshlabs.com).
8. When discarding the unit, comply with local rules or regulations. Batteries should never be thrown away or incinerated but disposed of in accordance with the local regulations concerning battery disposal. 
9. For additional information on the MA252 and other McIntosh Products please visit the McIntosh Website at [www.mcintoshlabs.com](http://www.mcintoshlabs.com).

## Output Terminal Connector

When cables with spade lugs are used for Loudspeaker Connection, the spade lugs need an opening of at least 3/10 inch (7.6mm)

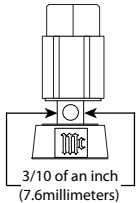

## Connector and Cable Information

### XLR Connectors

Below is the Pin configuration for the XLR Balanced Input Connectors on the MA252. Refer to the diagram for connection:

- PIN 1: Shield/Ground
- PIN 2: + Output
- PIN 3: - Output

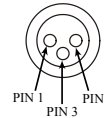

### Power Control Connector

The Power Control Output Jack sends Power On/Off Signals (+12 volt/0 volt) when another McIntosh Component is connected. A 3.5mm stereo mini phone plug is used for connection to the Power Control Output.

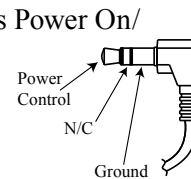

### Data Port Connector

The Data Out Ports send Remote Control Signals to Source Components. A 3.5mm stereo mini phone plug is used for connection.

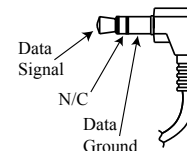

### Introduction

Now you can take advantage of traditional McIntosh standards of excellence in the MA252 Integrated Amplifier. The Power Amplifier Solid State section of the MA252, with a power output of 100 watts per channel, will drive a pair of quality Loudspeakers to a high level of performance.

The flexible Tube Preamplifier section provides connections for various analog input sources.

The MA252 reproduction is sonically transparent and absolutely accurate. The McIntosh Sound is “The Sound of the Music Itself.”

### Performance Features

#### • Power Output

The MA252 consists of 100 watts (8 ohm) or 160 watts (4 ohm) per channel Stereo Power Amplifier with less than 0.03% distortion. The McIntosh MA252 is designed for connection of a single 8 ohm or 4 ohm Loudspeaker per channel. The Power Amplifier uses ThermalTrak<sup>1</sup> Output Transistors for lower distortion and cool operation.

#### • Power Guard

The patented McIntosh Power Guard circuit prevents amplifier clipping and protects your valuable Loudspeakers.

#### • Sentry Monitor and Thermal Protection

McIntosh Sentry Monitor power output stage protection circuits ensure the MA252 will have a long and trouble free operating life. Built-in Thermal Protection Circuits guard against overheating.

#### • Electronic Output Switching

The Preamplifier uses Logic Controlled Electromagnetic Switches on all low level outputs and operating functions for reliable, noiseless, distortion free switching.

#### • Moving Magnet Phono Inputs

The MA252 Moving Magnet Input Circuitry uses the latest design to provide the lowest possible noise, distortion and flat frequency response.

#### • Tone Controls

The Bass and Treble Trim Controls provide up to 10dB of boost or cut. The MA252 remembers the Bass and Treble Setting for each input.

#### • Multifunction Display

The Front Panel Display indicates source selection, volume levels and setup functions.

#### • Power Control Output

A Power Control connection for convenient Turn-On of a McIntosh Component.

#### • Remote Control

The Data Port together with the supplied Remote Control provide control of McIntosh Source Components connected to the MA252.

#### • Special Power Supply

The large Power Transformer, multiple filter capacitors with 60 Joules of Energy Storage and regulated Power Supply ensure stable noise free operation even though the power line varies.

#### • McIntosh Custom Binding Posts

McIntosh Patented gold plated output terminals deliver high current output. They accept large diameter wire and spade lugs. Banana plugs may also be used only in the United States and Canada.

#### • Super Mirror Finish Chassis with Glass Panel

The famous McIntosh Stainless Steel Chassis with Super Mirror Finish ensures the pristine beauty of the MA252 will be retained for many years. The famous McIntosh Illuminated Glass Panel uses long life Light Emitting Diodes (LEDs).

<sup>1</sup> ThermalTrak™ and ON Semiconductor are trademarks of Semiconductor Components Industries, LLC



## Dimensions

The following dimensions can assist in determining the best location for your MA252. There is additional information on the next page pertaining to installing the MA252 into cabinets.

Front View of the MA252

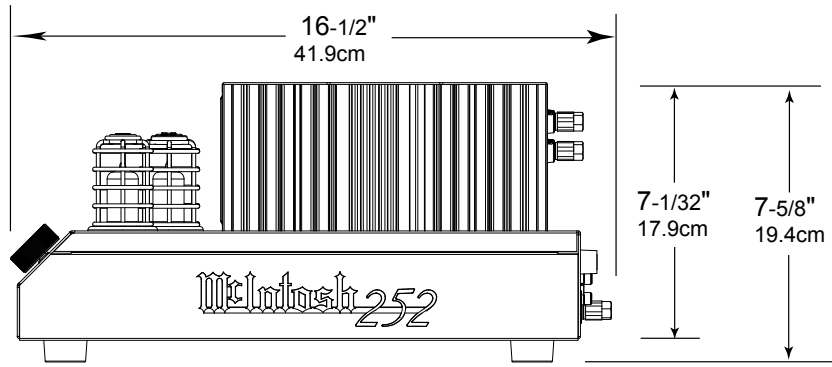

Left Side View of the MA252

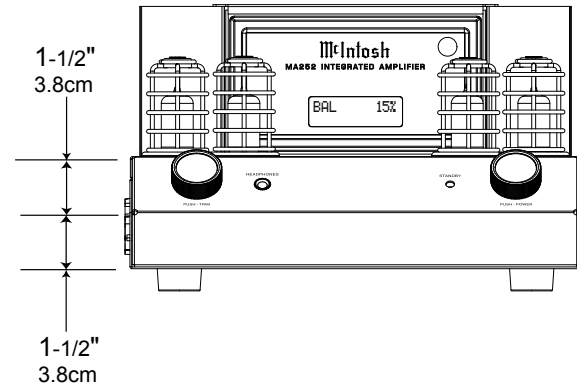

Top View of the MA252

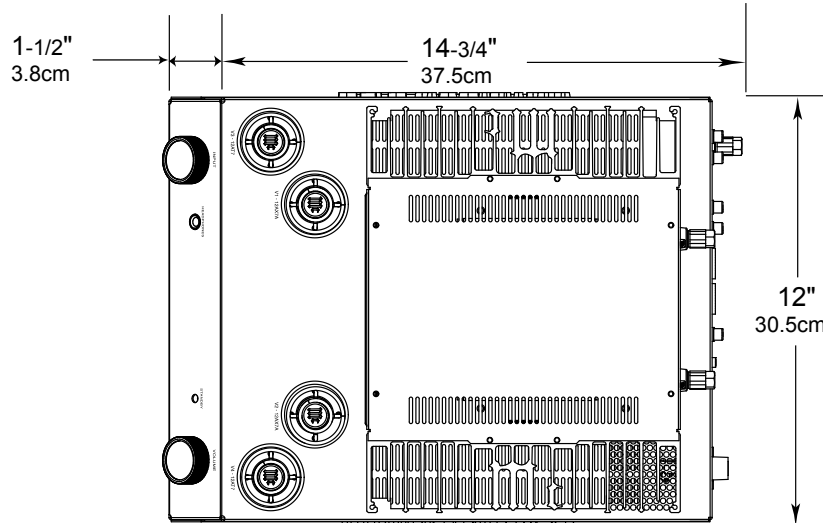

Right Side View of the MA252

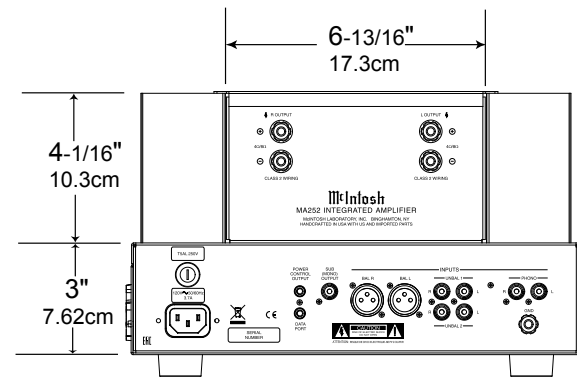



**Installation**

The MA252 Integrated Amplifier is designed to be placed upright on a table or shelf, standing on its feet. The required ventilation requirements are shown. Always provide adequate ventilation for your MA252. Cool operation ensures the longest possible operating life for any electronic instrument. Do not install the MA252 directly above a heat generating device, such as a Power Amplifier. Allow at least 6 inches (15.3cm) above the top, 5/8 inch (1.6cm) below the bottom and 2 inches (5.1cm) on each side of the Amplifier, so that airflow is not obstructed. Allow 18 inches (45.7cm) of depth for airflow and cable connections.

**MA252 Front View**

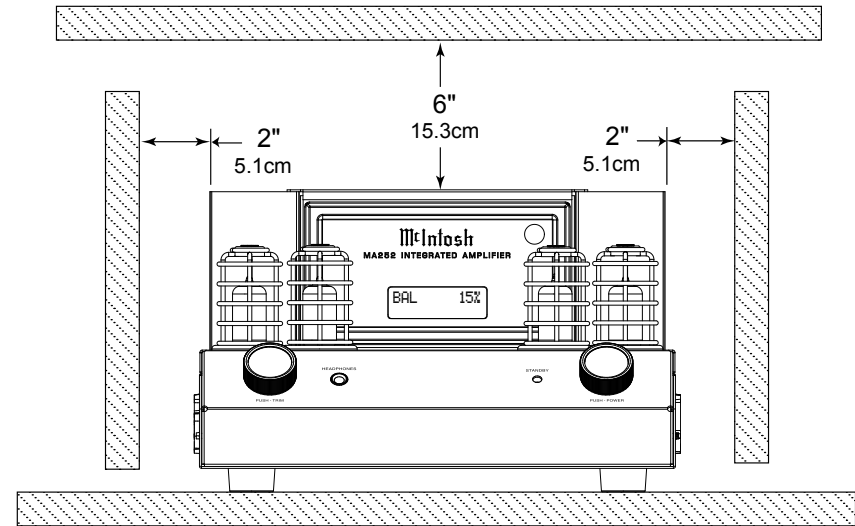

**MA252 Side View**

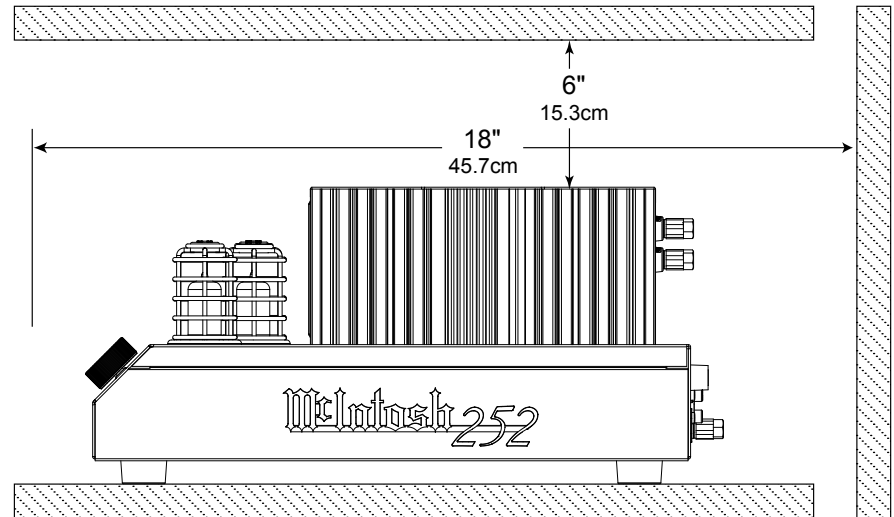



Right OUTPUT connections for a 4 or 8 ohm Loudspeaker

POWER CONTROL OUTPUT sends turn On/Off signals to a McIntosh Component when the MA252 is switched On/Off

Left OUTPUT connections for a 4 or 8 ohm Loudspeaker

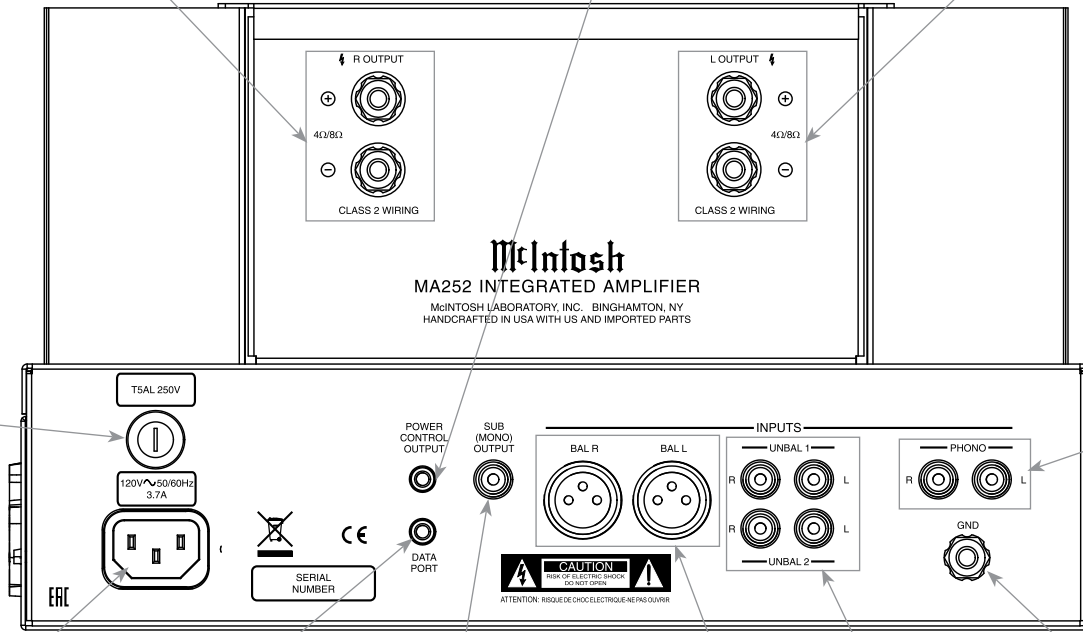

Main Fuse holder, refer to information on the back panel of your MA252 to determine the correct fuse size and rating

PHONO accepts signals from a Moving Magnet Phono Cartridge or a high output Moving Coil Cartridge

DATA PORT sends signals to a Source Component to allow control with the MA252 Remote Control

BALANCED INPUTS accept high level program source signals

GND terminal accepts a ground wire from a turntable

Connect the MA252 power cord to a live AC outlet. Refer to information on the back panel of your MA252 to determine the correct voltage for your unit

SUB (MONO) OUTPUT full frequency range Audio Output for connection to an actively powered Sub-Woofers

UNBALANCED INPUTS 1 and 2 accept high level program source signals

---

## Connecting Components

The MA252 has the ability to automatically switch power On/Off to McIntosh Source Components via the Power Control connections. The Data Port Connections allow for the remote operation of basic functions using the MA252 Remote Control.

The connection instructions below, together with the MA252 Input and Output Connection Diagram on the next page is an example of a typical audio system. Your system may vary from this, however the actual components would be connected in a similar manner. For additional information refer to “Connector and Cable Information” on page 6.

### **Power Control Connections:**

1. Connect a Control Cable from the MA252 POWER CONTROL OUTPUT Jack to the Power Control In on the Turntable.
2. Connect a Control Cable from the McIntosh Turntable Power Control Out Jack to the CD Player Power Control In Jack.
3. Connect any additional McIntosh Components in a similar manner, as outlined in steps 1 thru 2.

### **Data Control Connections:**

4. Connect a Control Cable from the MA252 DATA PORT Jack to the CD Player Data In Jack.
5. Connect another McIntosh Component in a similar manner instead of the CD Player Data In Jack, as outlined in step 7.

### **Audio Connections:**

6. Connect Balanced Cables from the MA252 BALANCED INPUT Connectors to the CD Player Audio Output.
7. Connect the Audio Cables coming from the Turntable to the MA252 PHONO Input Jacks (for a Moving Magnet Cartridge or a Moving Coil Cartridge with High Audio Output Level).
8. Connect any additional Components in a similar manner, as outlined in steps 6 and 7.

### **Ground Connections:**

9. Connect the Ground Cable coming from the Turntable to the MA252 GND Binding Post.

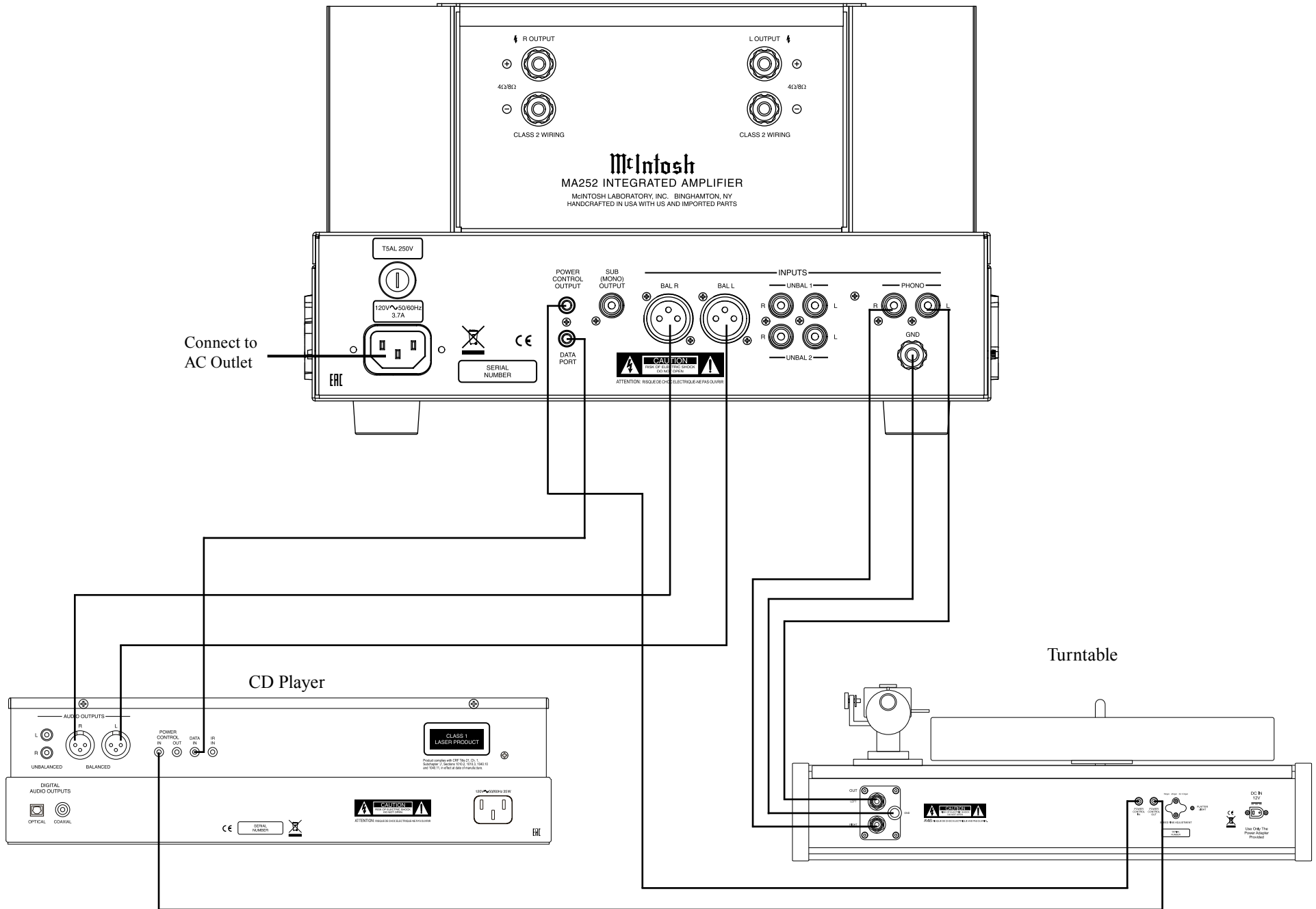

## Output Terminals

When connecting the Loudspeaker Hookup Cables to the MA252 Power Amplifier Output Terminals please follow the steps below:

1. Rotate the top of the Output Terminal Post counterclockwise until an opening appears. Refer to figures A and B.
2. Insert the Loudspeaker hookup cable into the Output Terminal Post opening or the cable spade lug around the center post of the Output Terminal. Refer to figure C.
3. Rotate the top of the Output Terminal Post clockwise until it is finger tight. Refer to figure D.
4. Place the supplied McIntosh Wrench over the top of the Output Terminal and rotate it one quarter of a turn (90°) to secure the Loudspeaker Cable Connection. **Do not over tighten.** Refer to figure E.

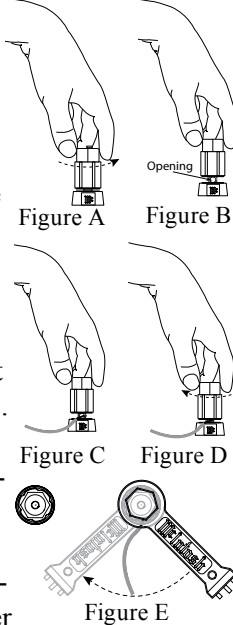

## How to Connect Loudspeakers

**Caution: Do not connect the AC Power Cord to the MA252 Rear Panel until after the Loudspeaker Connections are made. Failure to observe this could result in Electric Shock.**

The connection instructions below, together with the MA252 Connection Diagram located on the next page is an example of a typical audio system. Your system may vary from this, however the actual components would be connected in a similar manner. For additional information refer to “Connector and Cable Information” on page 6.

The McIntosh MA252 Power Amplifier Circuitry is designed for a Loudspeakers with an impedance of 8 Ohms or 4 Ohms. Connect a single Loudspeaker only to the Right and Left Output Terminals.

When connecting Loudspeakers to the MA252 it is very important to use cables of adequate size, so there is little to no power loss in the cables. The size is specified in Gauge Numbers or AWG (American Wire Gauge). The smaller the Gauge number, the larger the wire size:

Loudspeaker Cable Distance vs Wire Gauge Guide			
Loudspeaker Impedance	25 feet (7.62 meters) or less	50 feet (15.24 meters) or less	100 feet (30.48 meters) or less
2 Ohms	12AWG	10AWG	8AWG
4 Ohms	14AWG	12AWG	10AWG
8 Ohms	16AWG	14AWG	12AWG

1. Prepare the Loudspeaker Hookup Cable for attachment to the MA252 Power Amplifier:

Bare wire cable ends:

Carefully remove sufficient insulation from the cable ends, refer to figures F, G & H. If the cable is stranded, carefully twist the strands together as tightly as possible.

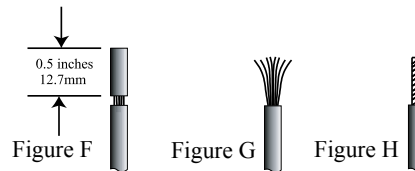

- Notes:
1. If desired, the twisted ends can be tinned with solder to keep the strands together.
  2. The prepared bare wire cable ends may be inserted into spade lug connectors.
  3. Banana plugs are for use in the United States and Canada only.

**Banana Plugs are for use in the United States and Canada only:**

2. Attach the previously prepared bare wire cable ends into the banana plugs and secure the connections. Refer to figure I.
3. Rotate the Output Terminal Post clockwise until it is finger tight. Refer to figure J. Then using the McIntosh Wrench, rotate the top of the Output Terminal one quarter of a turn (90°). **Do not over tighten.** Refer to figure E.
4. Referring to figure K, connect the Loudspeaker hookup cables with banana plugs into the hole at the top of the terminal to the MA252 Negative Output Terminal and Positive Output Terminal to the Loudspeaker Terminal Connections being careful to observe the correct polarities.

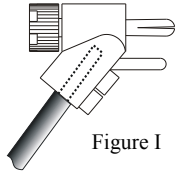

Figure I

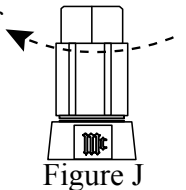

Figure J

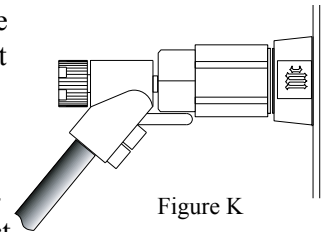

Figure K

Note: The illustration located on the separate folded sheet “Mc2B” is for connection to an 8Ω (ohms) Loudspeaker.

If the Loudspeaker’s impedance is in-between the available connections, use the nearest lower impedance connection. Refer to “General Information” Note 6 on page 6 for additional information.

**WARNING: Loudspeaker terminals are hazardous live and present a risk of electric shock. For additional instruction on making Loudspeaker Connections contact your McIntosh Dealer or McIntosh Technical Support.**

- Connect the MA252 power cord to an active AC outlet.

### Spade Lug or Wire Connections:

- Connect the Loudspeaker hookup cables to the MA252 Negative Output Terminal and Positive Output Terminal to the Loudspeaker Terminal Connections being careful to observe the correct polarities. Insert the spade lug connector or prepared section of the cable end into the terminal side access hole, and tighten the terminal cap until the cable is firmly clamped into the terminals so the lugs or wire cannot slip out. Refer to figures L and M.

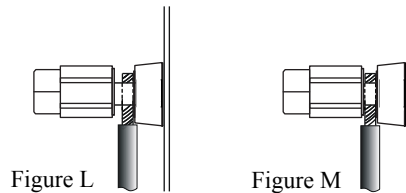

*Note: The illustration located on the separate folded sheet "Mc2B" is for connection to an 8Ω (ohms) Loudspeaker.*

Refer to "General Information" Note 6 on page 6 for additional information.

**WARNING: Loudspeaker terminals are hazardous live and present a risk of electric shock. For additional instruction on making Loudspeaker Connections contact your McIntosh Dealer or McIntosh Technical Support.**

- Connect the MA252 power cord to an active AC outlet.

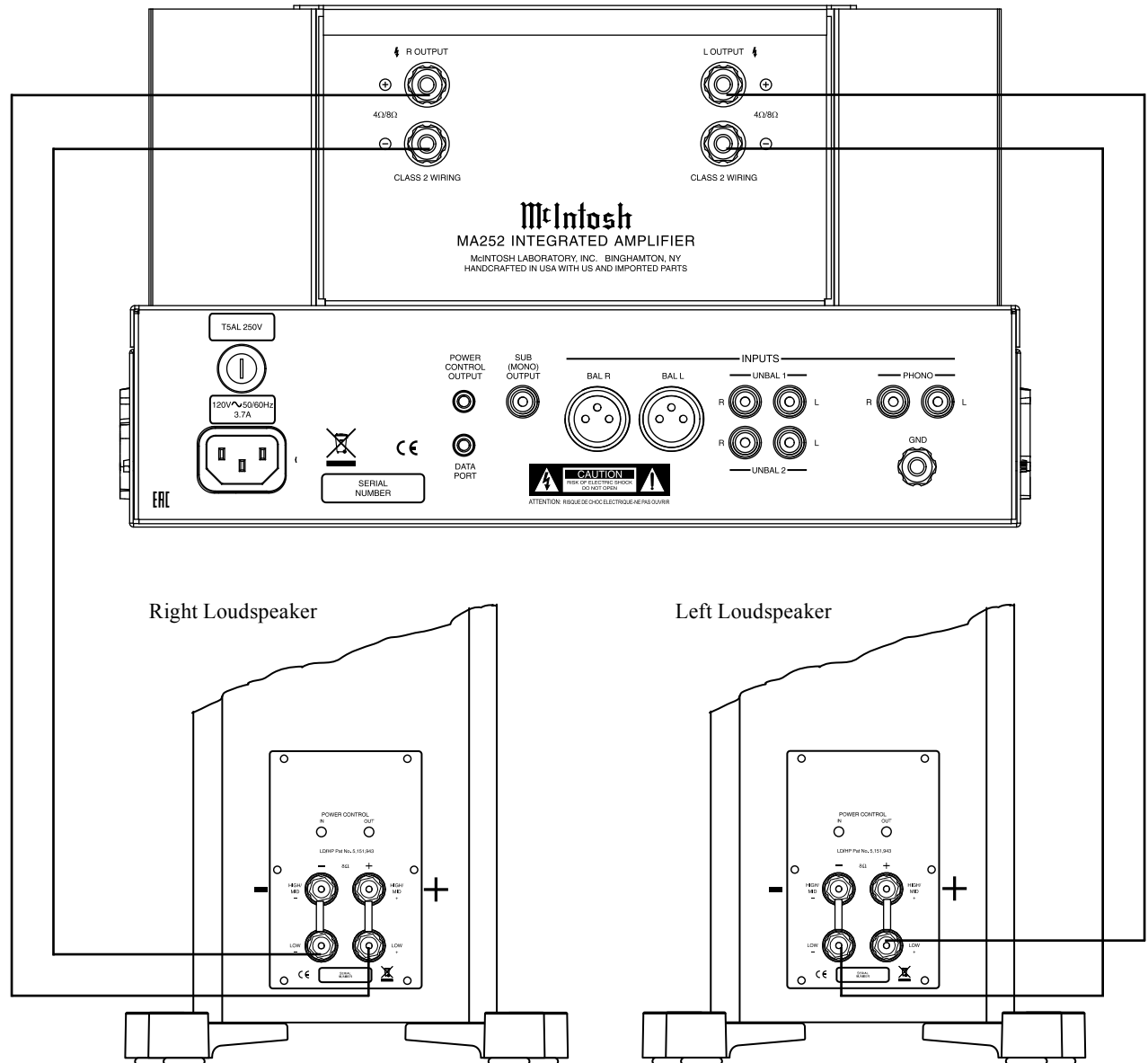





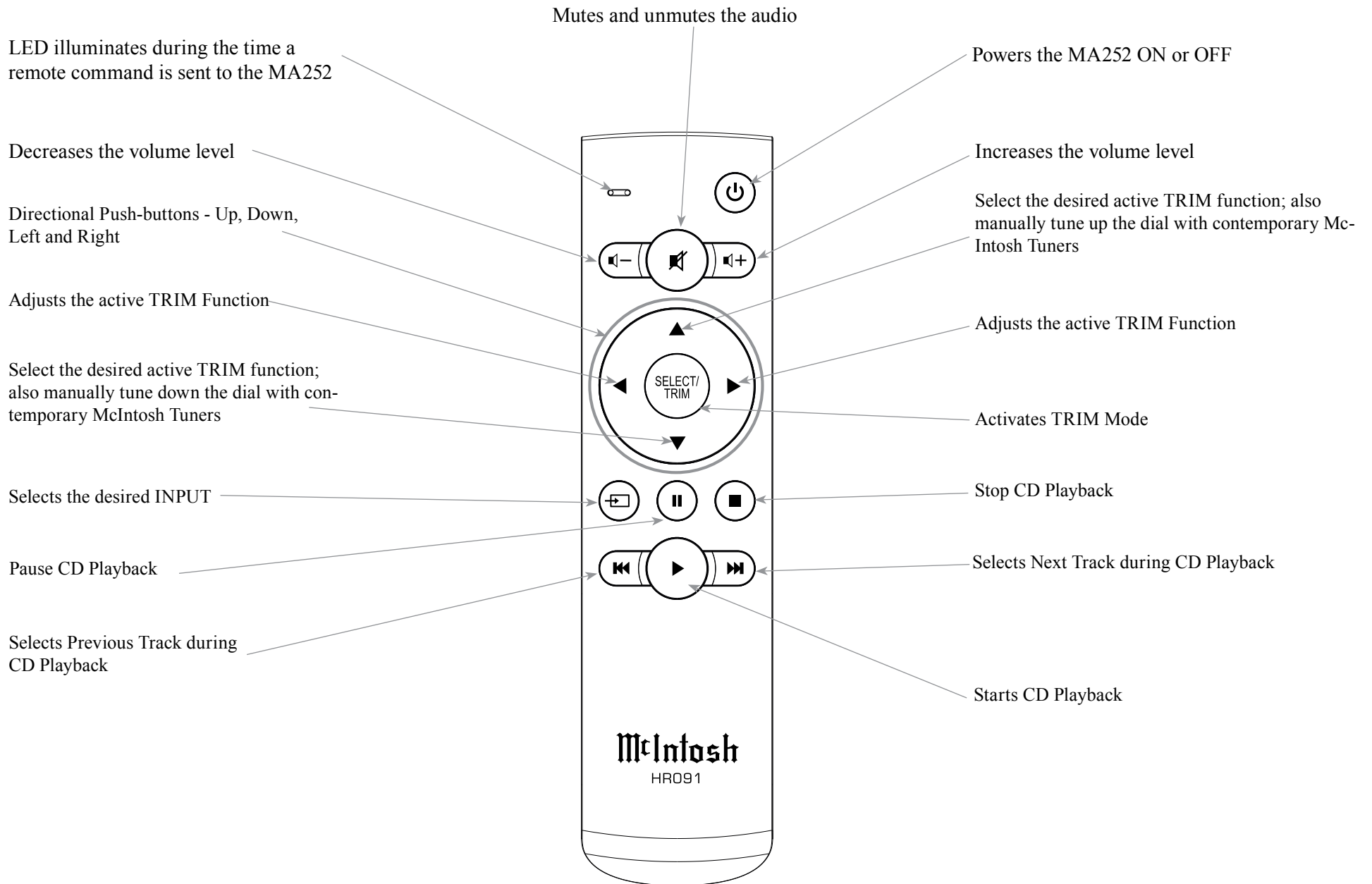

*Note: Push-buttons whose function is not identified above are for use with other McIntosh Products.*

## How to use the Remote Control



The supplied Remote Control performs the various Operating Functions for the MA252 Integrated Amplifier.

*Note: Refer to the "How to Operate" Section of this manual for additional information.*

### Input Source Selection

Press the Push-button  to select the desired program source.

### Volume

Press the  + or  - Push-buttons to increase or decrease the listening level.





### Mute

Press the  (Mute) Push-button to mute the audio and a second time to resume listening.

### Select Push-Button

Press the SELECT/TRIM Push-button to activate the Trim Mode. Then use the Directional Push-Buttons to select a Trim Mode Function and make changes.

### Directional Push-Buttons

After having pressed the SELECT Push-button, press the   (Up or Down) Push-buttons to scroll through the various Trim Functions. Then press the   (Left or Right) Push-buttons to make a change to the current Trim Setting.



INPUT Control used to select a source for listening and recording. The control is also used to enter the TRIM or SETUP Modes and select the various functions

Preamplifier Small Signal Vacuum Tube

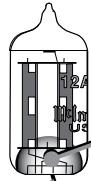

LED Illumination Color:  
Orange- Warmup Mode and  
Power Guard Activates  
Green - Normal Operation

IR Sensor receives commands from a Remote Control

VOLUME Control allows adjustment of the listening level for both channels. Switches the MA252 ON or OFF (Standby). Also used to change the various TRIM and SETUP Functions and Resets the microprocessors

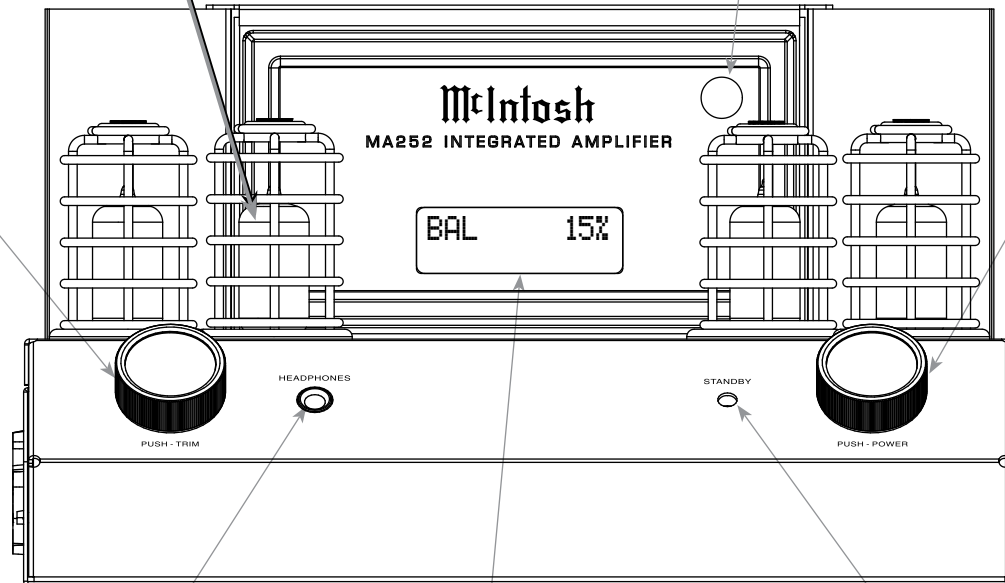

INFORMATION DISPLAY indicates the Sources, Volume, Trim Operational Functions and Setup Mode Settings

Connection for low impedance dynamic headphones, for private listening

STANDBY/ON LED Indicator

## How to Operate the Setup Mode

Your McIntosh MA252 has been factory configured to allow immediate enjoyment of superb audio without the need for further adjustments. If you wish to make changes to the factory default settings, a Setup Feature is provided to customize the operating settings using the Front Panel Information Display. Refer to the MA252 Front Panel Illustration on the previous page while performing the following steps.

*Note: If the MA252 is currently On, proceed to step 2.*

1. Press the STANDBY/ON Push-button on the Front Panel or press the  (Power ON) Push-button on the Remote Control to switch On the MA252. The MA252 will go through a brief startup initialization with the Front Panel Information Display first indicating “MA252”, followed by the last used source and volume setting. This is followed by the volume setting indication starting at zero and then increasing to the last used volume setting. Refer to figure 1.



Figure 1

2. Press and hold in the INPUT Control until the Front Panel Information Display indicates “MA252 V1.00, (or higher Firmware version) - S/N: AGA \_\_\_\_\_” (Serial Number). Refer to figure 2.



Figure 2

3. Rotate the INPUT Control to select the Setup Mode Menu item, “SETUP: Inputs, (Hold INPUT)”. Refer to figure 3.



Figure 3

Continue to rotate the INPUT CONTROL to view the other SETUP Mode Options.

4. To exit from the SETUP Mode, press and hold in the INPUT Control and the Front Panel Display will indicate its normal display. Refer to figure 1.

## Default Settings

The Default Settings Chart below indicates the Function Name, Default Setting and the Page Number for additional information.

Default Settings		
Function Name	Setting	Page No.
MA252	V_._._	19
INPUTS	On / Rename	19-21
DATA PORT	All Data	21
IR Codes	Normal	21
IR Sensor	Enabled	21
Power Mode	Enabled	21

## Firmware Version

The MA252 functionality is controlled by internal software that is known as Firmware. The Firmware for the MA252 can be identified at any time by utilizing the Setup Mode.

1. Press and hold in the INPUT Control to enter Setup Mode.
2. Referring to the Front Panel Information Display the number after the character “V” is the Firmware number. Refer to figure 2.

## Input Settings

The MA252 provides the ability to switch unused INPUTS Off (or back On if they have been previously switched Off). The default INPUT Names can be changed to match the name of the component connected to it or any other custom name desired (within 10 Characters).

### INPUT SWITCHED ON/OFF:

In the following example, the UNBAL 2 Input will be switched Off.

*Note: When an INPUT is switched Off, its name will no longer appear on the Front Panel Information Display when using the INPUT Control (Front Panel or Remote Control).*

1. Press and hold in the INPUT Control to enter the SETUP MODE. Refer to figure 2.

## Input Settings, con't

2. Rotate the INPUT Control until "SETUP: Inputs, (Hold INPUT)" appears on the Information Display. Refer to figure 3 on page 19.
3. Press and hold in the INPUT Control until "SETUP: UNBAL 2, On / Name (Hold IN)" appears on the Display. If necessary rotate the INPUT Control to select the UNBAL 2 Input. Refer to figure 5.

Figure 5

4. To switch the UNBAL 2 Input Off, rotate the VOLUME Control until the display indicates "SETUP: UNBAL 2, Off". Refer to figure 6.

Figure 6

5. Exit the SETUP Mode by several presses of the INPUT Control.

In the following example, the UNBAL 2 Input will be switched On.

*Notes: 1. When an INPUT is switched ON, its name will appear on the Front Panel Information Display when using the INPUT Control (Front Panel or Remote Control).*

6. Press and hold in the INPUT Control to enter the SETUP MODE. Refer to figure 2, on page 19.
7. Rotate the INPUT Control until "SETUP: Inputs, (Hold INPUT)" appears on the Information Display. Refer to figure 3, on page 19.
8. Press and hold in the INPUT Control until "SETUP: UNBAL 2, Off" appears on the Display. If necessary rotate the INPUT Control to select the UNBAL 2 Input. Refer to figure 6.
9. To switch the UNBAL 2 Input On, rotate the VOL-

UME Control until the display indicates "SETUP: UNBAL 2, On / Name".

10. Exit the SETUP Mode by several presses of the INPUT Control.

### RENAME INPUT:

In the following example, the BAL (BALANCED) Input will be renamed to match up with the component connected (refer to page 8, step 6).

The MA252 Default Input Names (UNBAL 1, BAL, PHONO, etc.) as indicated on the Front Panel Display can be customized to a different name up to ten characters long (TUNER, CD PLAYER, etc.). The available characters for renaming the input include the following: ! < > \* , / - \_ 0 1 2 3 4 5 6 7 8 9 A B C D E F G H I J K L M N O P Q R S T U V W X Y Z .

In the following example, the BAL Input will be renamed to "MEDIA SVR".

11. Press and hold in the INPUT Control to enter the SETUP MODE. Refer to figure 2, on page 19.
12. Rotate the INPUT Control until "SETUP: Inputs, (Hold INPUT)" appears on the Information Display. Refer to figure 7.

Figure 7

13. Press and hold in the INPUT Control until "SETUP: UNBAL 1, On/Name(Hold IN)" appears on the Display. Rotate the INPUT Control to select the BAL Input. Refer to figure 8.

Figure 8

14. Press and hold in the INPUT Control until "RENAME: BAL, >BAL <" appears on the Dis-

play. The character "B" is flashing to indicate it is ready to be changed. Refer to figure 9.

Figure 9

15. Rotate the VOLUME (ADJUST) Control to change the character "B" to "C". Refer to figure 10.

Figure 10

16. Rotate the INPUT Control until the character "A" is flashing, then rotate the VOLUME (ADJUST) Control to change the character "A" to "D". Refer to figure 11.

Figure 11

17. Rotate the INPUT Control until the character "L" is flashing, then rotate the VOLUME (ADJUST) Control until the "\_" empty space to the right of character D is flashing. Refer to figure 12.

Figure 12

18. Rotate the INPUT Control until the "\_" empty space to the right of the just entered empty space is flashing, then rotate the VOLUME (ADJUST) Control to change the "\_" empty space to character to "P". Refer to figure 13.

Figure 13

19. Rotate the INPUT Control until the “\_” empty space to the right of character P is flashing, then rotate the VOLUME (ADJUST) Control to change the “\_” empty space to character to “L”. Refer to figure 14.



Figure 14

20. Repeat step 19 until the new name of “RENAME: BAL, CD PLAYER” is indicated on the Front Panel Display. Refer to figures 15 thru 18.



Figure 15



Figure 16



Figure 17



Figure 18

21. To save the new name, press and hold in the INPUT Control until “SETUP: CD PLAYER, ON / Rename” appears on the Front Panel Information Display. Refer to figure 19.



Figure 19

22. Exit the SETUP Mode by several presses of the INPUT Control.

## Data Port

Data Port Connection between the MA252 and a McIntosh Source Component allow for basic function control of the source component using the MA252 Remote Control. By default, the Data Port setting of “All Data” sends the received IR Data to the DATA PORT Output Jack. To dedicate the Data Port for only one MA252 source component perform the following Steps:

1. Press and hold in the INPUT Control to enter the SETUP MODE. Refer to figure 2 on page 19.
2. Rotate the INPUT Control until “SETUP: Data Ports, All DATA” appears on the Information Display. Refer to figure 20.
3. Rotate the VOLUME (ADJUST) Control to select the desired MA252 Input. Refer to figure 21.



Figure 20



Figure 21

4. Exit the SETUP Mode by several presses of the INPUT Control.

## Remote Control Codes

The HR091 Remote Control included with the MA252 utilizes the NORMAL McIntosh Control Codes. The Second Set of Control Codes the MA252 will respond to is referred to as the ALTERNATE Codes. The Alternate Codes are used when the MA252 is used in the same location as another McIntosh Preamplifier and/or A/V Processor. This will prevent the Remote Control from affecting the operation of both units at the same time. To activate the Remote Control ALTERNATE Codes perform the following steps:

1. Press and hold in the INPUT Control to enter the SETUP MODE. Refer to figure 2 on page 19.
2. Rotate the INPUT Control until “SETUP: IR Codes, Normal” appears on the Information Display. Refer to figure 22.

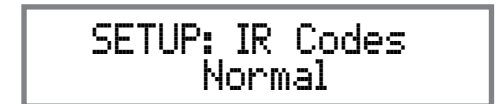

Figure 22

3. Rotate the VOLUME (ADJUST) Control to the Alternate Codes. Refer to figure 23.



Figure 23

4. Exit the SETUP Mode by several presses of the INPUT Control.

## IR Sensor

The MA252 Front Panel Sensor, which receives the signals from the HR091 Remote Control, can be switched off to prevent interference when other Remote Control IR Signals are received. To de-activate the Front Panel IR Sensor perform the following steps:

1. Press and hold in the INPUT Control to enter the SETUP MODE. Refer to figure 2 on page 19.
2. Rotate the INPUT Control until “SETUP: Front IR, Enabled” appears on the Information Display. Refer to figure 24.



SETUP: Front IR  
Enabled

Figure 24

3. Rotate the VOLUME (ADJUST) Control to select Disabled. Refer to figure 25.



SETUP: Front IR  
Disabled

Figure 25

4. Exit the SETUP Mode by several presses of the INPUT Control.

## Power Mode

The MA252 incorporates an Auto Off Feature, which automatically places the preamplifier into the Power Saving Standby/Off Mode. This occurs approximately 30 minutes after there has been an absence of user activity (includes changes to any of the Operation Functions such as source selection, volume adjustment, etc.) or absence of an audio signal. If it is desirable to disable the Auto Off Feature perform the following steps:

1. Press and hold in the INPUT Control to enter the SETUP MODE. Refer to figure 2 on page 19.
2. Rotate the INPUT Control until “SETUP: Auto Off, Enabled” appears on the Information Display. Refer to figure 26.



SETUP: Auto Off  
Enabled

Figure 26

3. Rotate the VOLUME (ADJUST) Control to select Disabled. Refer to figure 27.



SETUP: Auto Off  
Disabled

Figure 27

4. Press the INPUT Control to exit the Setup Mode.

## Factory Reset

If it becomes desirable to reset all the adjustable settings (Setup and Trim Settings) to the factory default values, perform the following steps:

1. Press and hold in the INPUT Control to enter the SETUP MODE. Refer to figure 2 on page 19.
2. Rotate the INPUT Control until “FACTORY RESET, (Hold INPUT)” appears on the Information Display. Refer to figure 28.



FACTORY RESET  
(Hold INPUT)

Figure 28

3. Press and hold in the INPUT Control until “FACTORY RESET, In Progress!” appears on the Information Display, then release the INPUT Control. Refer to figures 29 and 30.



FACTORY RESET  
In Progress

Figure 29



FACTORY RESET  
Completed!

Figure 30

4. Press the Front Panel STAND/BY Push-button to switch On the MA252.







## How to Operate the MA252

### Power On and Off

The Red LED to the left of the VOLUME Control lights to indicate the MA252 is in Standby mode. To switch ON the MA252, Press the VOLUME Control on the Front Panel or press the  Push-button on the Remote Control. The MA252 will go through a Tube Warmup Initialization procedure. Refer to figure 50.

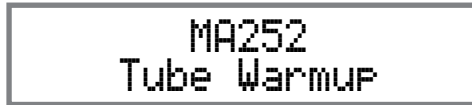



Figure 50

This is followed by the Front Panel Display indicating the last used source and the volume setting starting at zero and then increasing to the last used volume setting. Refer to figures 51, 52 and 53. To switch OFF the MA252, press the VOLUME Control on the Front Panel or press the  Power Push-button on the Remote Control.

*Notes: 1. For an explanation of the Remote Control Push-button functions, refer to pages 16 and 17.*

*2. During the Tube Warm-Up period of time no sound will be heard. The Small Signal Vacuum*

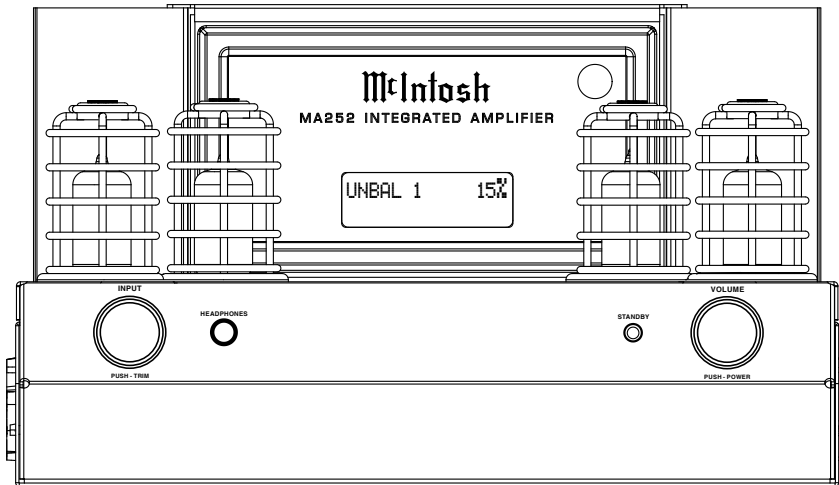

Figure 51

*Tubes LED will be illuminated with the Amber Color. Then sound will be heard and the LED illumination color of the Small Signal Vacuum Tubes will change to the Green Color.*



Figure 52





Figure 53

### Source Selection

Rotate the INPUT Control to select the desired source or press the  Input Push-button on the Remote Control. Refer to figures 51 and 54.

### Volume Control

Rotate the Front Panel VOLUME Control or use the  + or  - Push-buttons on the Remote Control for the desired listening level. Refer to figures 51 and 54.

### Trim Functions

The MA252 has various Trim Selections with Adjustments. The Trim Functions include Balance, Input Trim Level, Tone Controls, Bass, Treble and Display. The Trim Settings are stored in memory independently for each Input Source Selected.

*Note: Selection and Adjustment of all Trim Functions may be performed by pressing the Front Panel INPUT Trim Control and*

*then rotating it to select the desired Trim Function. Then use the VOLUME Adjust Control to change the setting. The Remote Control TRIM Push-Button together together with the Directional Push-buttons can also be used to select a TRIM Function and make Trim settings. Refer to figures 51 and 54.*

After approximately 5 seconds the Display returns to indicate the Source Selection and Volume Level.

### BALANCE

Listening balance varies with different program sources, room acoustics and listening positions relative to the Loudspeakers. Use the Balance (Trim Function) as needed to achieve approximately equal listening volume levels in each Loudspeaker. To adjust the Balance perform the following:

1. Press the TRIM Push-button repeatedly on the Remote Control until "L BALANCE R, ||" appears on the Front Panel Display. Refer to figure 55.



Figure 55

*Note: The Front Panel INPUT/Trim Control may also be used.*

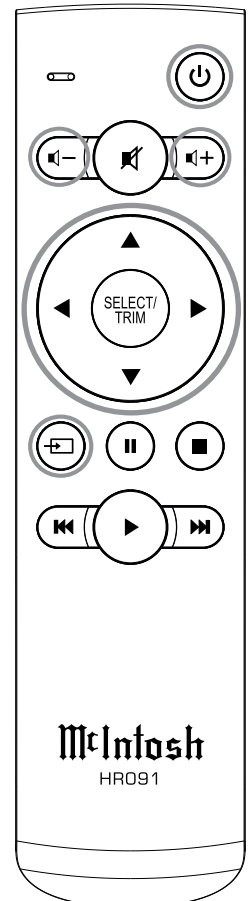

Figure 54

2. Rotate the VOLUME Control or press the ◀ ▶ (Left or Right) directional Push-buttons to make a change to the current Balance Setting to emphasize the Right Channel (refer to figure 56) or the Left Channel (refer to figure 57).



Figure 56



Figure 57

The Front Panel Display indicates the relative Balance changes. After approximately 6 seconds, the Display returns to indicate the Source Selection and Volume Level. To verify the Balance setting without changing it, use the TRIM Push-button and select Balance.

TRIM LEVEL

Source Components can have slightly different volume levels resulting in the need to readjust the MA252 Volume Control when switching between different sources. The MA252 allows the adjustment of levels for each Source, ensuring the same relative volume. To adjust the Trim Level for the currently selected Input Source perform the following steps:

1. Select “INPUT TRIM” as indicated on the Front Panel Information Display. Refer to figures 51, 54 and 58.



Figure 58

2. Adjust the Trim Level of each Input to match the average volume level of the Input most frequently

listened to. The range of adjustment is ± 6.0dB in half dB steps. Refer to figures 59 and 60.



Figure 59



Figure 60

After approximately 6 seconds the Information Display returns to indicate the Source Selection and Volume Level.

TONE CONTROL

The Tone Controls default setting is On. The TRIM TREBLE and BASS Settings may be adjusted for the currently selected Input Source. When the Tone Controls are Disabled the previous settings for Treble and Bass are bypassed from the signal path. To deactivate Tone Controls perform the following:

1. Select the desired Input Source.
2. Press the TRIM Push-button on the Remote Control until “TONE CONTROLS, On” appears on the Front Panel Display. Refer to figure 61.

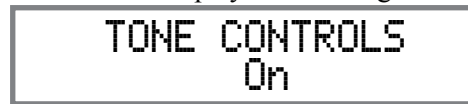

Figure 61

3. Press ◀ (Left) directional Push-button to deactivate the Tone Controls. Refer to figure 62.

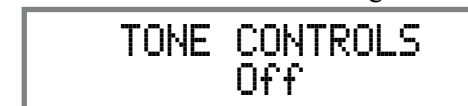

Figure 62

*Note: When the TONE CONTROLS Setting is Off, the BASS and TREBLE Controls will be inactive.*

After approximately 6 seconds the Display returns to indicate the Source Selection and Volume Level.

BASS

The Intensity of the Low Frequencies in the music can be increased or decreased by using the Trim Select and Trim Adjust Controls. To make an adjustment perform the following:

1. Use the Front Panel INPUT/TRIM Control or press the TRIM Push-button on the Remote Control until “BASS, 0 dB” appears on the Front Panel Information Display. Refer to figure 63.



Figure 63

2. Rotate the VOLUME Control or press the ◀ ▶ (Left or Right) directional Push-buttons to increase (refer to figure 64) or decrease (refer to figure 65) the volume level of the low frequencies.



Figure 64



Figure 65

The Front Panel Display indicates the Bass changes in steps from +10dB to -10dB. After approximately 6 seconds the Display returns to indicate the Source Selection and Volume Level.

TREBLE

The Intensity of the High Frequencies in the music can be increased or decreased by using the Trim Select and Trim Adjust Control. To make an adjustment per-



## How to Operate the MA252, con't

form the following:

1. Use the Front Panel INPUT/TRIM Control or the TRIM Push-button on the Remote Control until "TREBLE, 0 dB" appears on the Front Panel Information Display. Refer to figure 66.
2. Rotate the VOLUME Control or press the ◀ ▶



Figure 66

(Left or Right) directional Push-buttons to increase (refer to figure 67) or decrease (refer to figure 68) the volume level of the high frequencies.



Figure 67



Figure 68

The Front Panel Display indicates the Treble changes

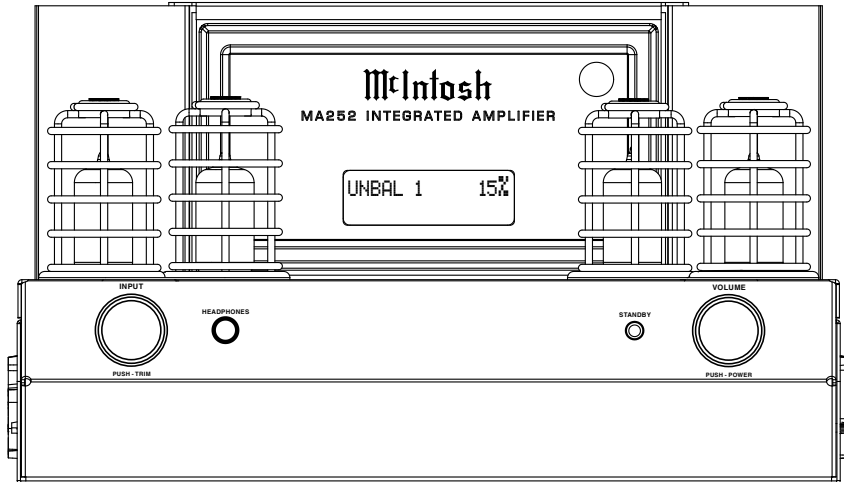

Figure 51

in steps from +10dB to -10dB. After approximately 6 seconds the Display returns to indicate the Source Selection and Volume Level.

### INFORMATION DISPLAY

The MA252 Front Panel Information Display default setting is for the display to be "Always On". The "Auto Off" setting is an option when the Display will only be On during a change in the operational control settings. To active the "Display Auto Off" setting performing the following steps:

1. Use the Front Panel INPUT/TRIM Control or the TRIM Push-button on the Remote Control until "DISPLAY, Always On" appears on the Front Panel Information Display. Refer to figure 69.



Figure 69

2. Rotate the VOLUME Control or press the ◀ ▶ (Left or Right) directional Push-buttons to select "DISPLAY, Auto Off" as indicated on the Front Panel Information Display. The Display will be active during the time the Front Panel Controls or Remote Control Operational Functions are being changed. Then 8 seconds later the Display will be switched Off. Refer to figure 70.



Figure 70

After approximately 5 seconds the Information Display returns to indi-

cate the Source Selection and Volume Level.

### Trim

Press the Front Panel INPUT/TRIM Control to activate the MA252 Trim Functions. Rotate the Front Panel INPUT/Trim Control to select the desired Trim Function and then rotate the VOLUME Control to vary or make changes. Refer to figure 51. The Remote Control ◀ ▶ (Left or Right) directional Push-buttons to may also be used to vary or make changes. Approximately 5 seconds after Trim Function Selection and/or adjustments have stopped, the MA252 will switch off the Trim Mode.

### Mute

Press the Mute Push-button on the Remote Control to Mute the Audio. The Front Panel Display will indicate the Source Name and with the word MUTE in place of the actual volume setting. Refer to figure 71.



Figure 71

Press the Mute Push-button a second time or adjust the Volume and the MA252 will un-mute.

### Headphones Jack

Connect a pair of dynamic headphones to the Headphone Jack with a 1/4" (0.635cm) stereo phone type plug for private listening. The Loudspeakers connected to the MA252 will be automatically muted.

*Note: The Headphone Output is optimized for impedances ranging from 20 to 600 ohms.*

### Power Guard

During normal operation, the Small Signal Vacuum

Tubes LED Illumination is the color green. During peaks in the audio signals when the Power Guard Circuitry is activated, the LED Illumination will change to the amber color.

**Protection Circuitry**

In the event the MA252 over heats, due to improper ventilation, high ambient temperature and/or impedance mismatch, the internal protection circuits will activate. The small Signal Vacuum Tubes normal LED Illuminated Color of Green, will change to an Amber Color. The Audio Sound will also be muted at that time.

When the MA252 has returned to a safe operating temperature, normal operation will resume, Audio Sound will be heard and the small Signal Vacuum Tubes LED Illuminated Color of Green will become active.

**Reset of the Microprocessors**

In the unlikely event the controls of the MA252 stop functioning, the microprocessors can be reset by performing the following:

1. Press and hold in the Front Panel VOLUME CONTROL until the STANDBY/ON LED Indicator switches Off.
2. Then release the VOLUME CONTROL and the MA252 will switch Off.
3. When the STANDBY/ON LED is illuminated press the VOLUME CONTROL and the MA252 will resume normal operation.













## Amplifier Specifications

### Power Output Stereo

Minimum sine wave continuous average power output per channel, with both channels operating is:  
100 watts into 8 ohm load  
160 watts into 4 ohm load

### Output Load Impedance

8 or 4 ohms

### Rated Power Band

20Hz to 20,000Hz

### Total Harmonic Distortion

0.03% maximum with both channels operating from 250 milliwatts to rated power, 20Hz to 20,000Hz

### Intermodulation Distortion

0.03% maximum, if the instantaneous peak power output does not exceed twice the rated power output for any combination of frequencies from 20Hz to 20,000Hz.

### Dynamic Headroom

1.8dB

### Wide Band Damping Factor

Greater than 200 - 8 ohm, Greater than 100 - 4 ohm

### Power Guard

Less than 2% THD with up to 16dB overdrive at 1,000Hz

### Frequency Response

+0, -0.5dB from 20Hz to 20,000Hz  
+0, -3dB from 10Hz to 100,000Hz

### Sensitivity (for rated output/8 ohm load)

High Level - 300mV unbalanced, 600mV balanced  
Phono - 3.0mV

### SUB (Mono) Output (for rated input)

1.7V unbalanced (6V Maximum)

### Signal To Noise Ratio (A-Weighted)

High Level - 97dB below rated output  
Phono - 80dB below 5mV input

### Input Impedance

High Level - 20K ohms  
Phono - 47K ohms; 50pF

### SUB (Mono) Output Impedance

200 ohms

### Maximum Input Signal

High Level - 4V unbalanced, 8V balanced  
Phono - 40mV

### Voltage Gain

High Level to Amp Output: 40dB  
High Level to Sub (Mono) Output: 15dB  
Phono to Amp Output: 80dB  
Phono to Sub (Mono) Output: 55dB

### Tone Controls

Bass  $\pm$  10dB (1dB steps) @ 70Hz  
Treble  $\pm$  10dB (1dB steps) @ 10,000Hz

### Headphone Impedance

20 to 600 ohms

### Power Control Output

12VDC, 25mA

## General Specifications

### Power Requirements

*Field AC Voltage conversion of the MA252 is not possible. The MA252 is factory configured for one of the following AC Voltages:*

100 Volts, 50/60Hz at 4.4 amps  
110 Volts, 50/60Hz at 3.7 amps  
120 Volts, 50/60Hz at 3.7 amps  
220 Volts, 50/60Hz at 2.0 amps  
230 Volts, 50/60Hz at 1.9 amps  
240 Volts, 50/60Hz at 1.9 amps  
Standby: Less than 0.5 watt

*Note: Refer to the rear panel of the MA252 for the correct voltage.*

### Overall Dimensions

Width is 12 inches (30.5cm)  
Height is 7-5/8 inches (19.4cm) including feet  
Depth is 18 inches (45.7cm) including the Cables

### Weight

28 pounds (12.7 kg) net, 37 pounds (16.8 kg) in shipping carton

### Shipping Carton Dimensions

Width is 22-1/4 inches (56.5cm)  
Depth is 19-1/4 inches (48.9cm)  
Height is 13-1/2 inches (34.3cm)

## Packing Instructions

In the event it is necessary to repack the equipment for shipment, the equipment must be packed exactly as shown below. It is very important that the four feet are attached to the bottom of the equipment. This will ensure the proper equipment location on the bottom foam pad. Failure to do this will result in shipping damage.

To protect the tubes during shipment, the Foam Insert removed from the MA252 needs to be re-inserted. Follow the unpacking instructions on pages 4-5 in the reverse order.

Use the original shipping carton and interior parts only if they are all in good serviceable condition. If a shipping carton or any of the interior part(s) are needed, please call or write Customer Service Department of McIntosh Laboratory, refer to page 2. Please see the Part List for the correct part numbers.

### MA252 Packing Material List

Quantity	Part Number	Description
1	034580	Shipping carton
2	034582	Foam Top/Bottom
1	034577	Foam End Cap Pad Top
1	034578	Foam End Cap Pad Bottom
1	034581	Corrugated Bottom Pad
1	034579	Foam Insert (for protecting the Tubes during shipping)
1	041855	Warning Sheet
4	400159	10-32 x 3/4 inch screw
4	163185	Feet

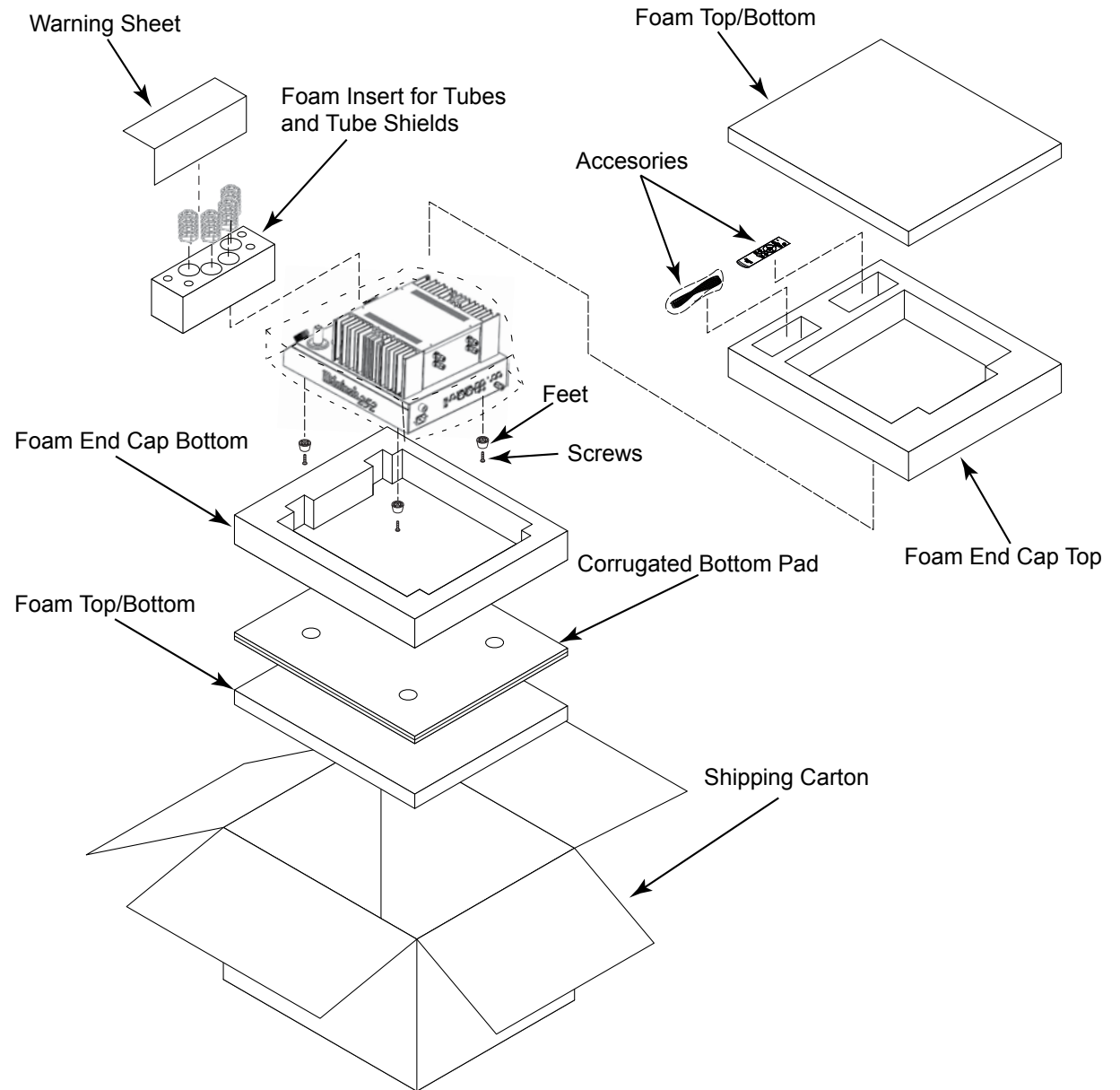



McIntosh Laboratory, Inc.  
2 Chambers Street  
Binghamton, NY 13903  
[www.mcintoshlabs.com](http://www.mcintoshlabs.com)

The continuous improvement of its products is the policy of McIntosh Laboratory Incorporated who reserve the right to improve design without notice.  
Printed in the U.S.A.