



McIntosh Laboratory, Inc. 2 Chambers Street Binghamton, New York 13903-2699 Phone: 607-723-3512 www.mcintoshlabs.com

MC2152

Tube Power Amplifier

Owner's Manual





Important Safety Information is supplied in a separate document “Important Additional Operation Information Guide”

Thank You

Your decision to own this McIntosh MC2152 Tube Power Amplifier ranks you at the very top among discriminating music listeners. You now have “The Best.” The McIntosh dedication to “Quality,” is assurance that you will receive many years of musical enjoyment from this unit.

Please take a short time to read the information in this manual. We want you to be as familiar as possible with all the features and functions of your new McIntosh.

Please Take A Moment

The serial number, purchase date and McIntosh Dealer name are important to you for possible insurance claim or future service. The spaces below have been provided for you to record that information:

Serial Number: _____

Purchase Date: _____

Dealer Name: _____

Technical Assistance

If at any time you have questions about your McIntosh product, contact your McIntosh Dealer who is familiar with your McIntosh equipment and any other brands that may be part of your system. If you or your Dealer wish additional help concerning a suspected problem, you can receive technical assistance for all McIntosh products at:

McIntosh Laboratory, Inc.
2 Chambers Street
Binghamton, New York 13903
Phone: 607-723-3512
Fax: 607-724-0549

Customer Service

If it is determined that your McIntosh product is in need of repair, you can return it to your Dealer. You can also return it to the McIntosh Laboratory Service Department. For assistance on factory repair return procedure, contact the McIntosh Service Department at:

McIntosh Laboratory, Inc.
2 Chambers Street
Binghamton, New York 13903
Phone: 607-723-3515
Fax: 607-723-1917

Table of Contents

Safety Instructions.....	2
(Separate Sheet)	Important Additional
	Operation Information Guide
Thank You and Please Take a Moment.....	2
Technical Assistance and Customer Service	2
Table of Contents	2
Unpacking the MC2152 and Ventilation.....	3-5
General Information	6
Connector Information	6
Introduction.....	7
Performance Features	7
Dimensions	8
Rear Panel Connections, Fuse Holder and Switches ..	9
How to Connect for Operation.....	10-11
Connection Diagram (Separate Sheet)	Mc1A
Front Panel Controls and Indicators.....	12
How to Operate.....	13
Photos.....	14-17
Specifications.....	18
Packing Instruction.....	19

IMPORTANT!

**INSTRUCTIONS FOR REMOVAL
OF FOAM INSERT OVER THE
VACUUM TUBES PRIOR TO
CONNECTING THE A.C. POWER
SUPPLY CORD, START ON THE
NEXT PAGE.**





Unpacking the MC2152

Caution: To prevent damage to the MC2152 Vacuum Tubes during shipping, there is a special foam insert surrounding the Vacuum Tubes of the Power Amplifier.

The Foam Insert must be removed from the MC2152 before connecting the AC Power Supply Cord to the Power Amplifier.

Failure to do so has the potential of a Fire Hazard, resulting in damage to the MC2152 and the surrounding environment.

Follow these instructions for removal of the packing foam before connecting the AC Power Supply Cord to the MC2152.

In order to remove the foam insert surrounding the Vacuum Tubes on the MC2152, it is necessary to temporarily remove the operational Tube Shield Metal Cover. After the foam insert is removed, the Tube Shield Metal Cover is to be re-installed for proper and safe opera-

tion of the MC2152 Power Amplifier. The Tube Shield Metal Cover provides protection from the hazardous voltages inside the MC2152. The MC2152 has no user serviceable parts, including the Vacuum Tubes. If repairs are needed they must be performed by an authorized McIntosh Service Agency.

1. Orient the MC2152 so the Front of the Power Amplifier is facing you and remove the Warning Sheet. Refer to figure 1A.
2. Referring to figure 2B (a partial side view of the MC2152) to temporarily remove the two screws located on the top of the Tube Shield Metal Cover by using a Phillips Head #2 Screw Driver.
3. Carefully lift up and remove the Tube Shield Metal Cover from the MC2152. Refer to figure 3C.
4. Place the Tube Cover and the previously removed chassis screws in a safe location, as the Tube Cover will be reinstalled.
5. Carefully lift up and remove the Foam Insert from the MC2152 exposing the Vacuum Tubes. Refer to figures 4D and 5E.
6. Carefully place the previously removed Tube Cover on top of the MC2152. Refer to figures 6F and 7G.
7. Secure the Cover to the MC2152 Chassis using the previously removed Tube Cover Screws. Refer to figure 8H.

Note: Save the Foam Insert and Warning Sheet with the MC2152 Shipping Carton for possible future use.

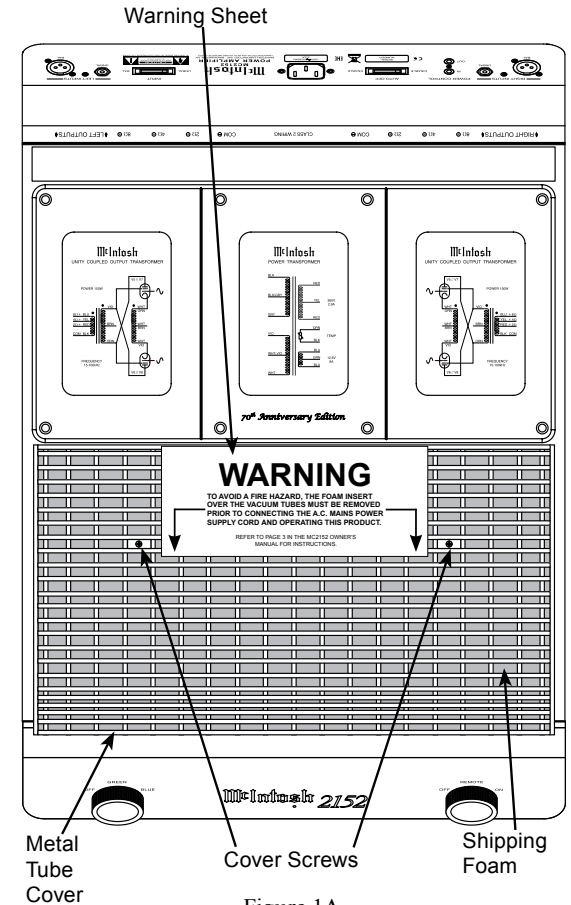

Figure 1A

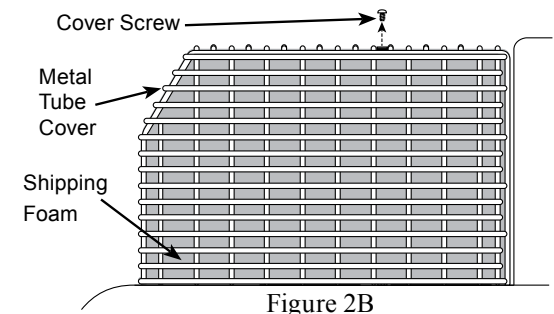

Figure 2B

Figure 3C

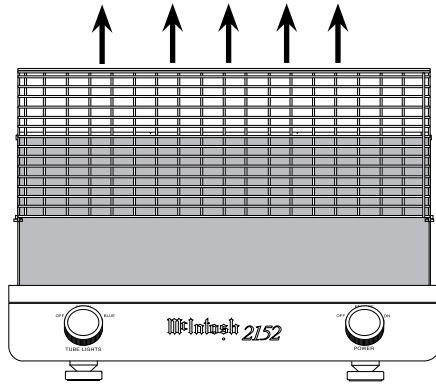

Figure 6F

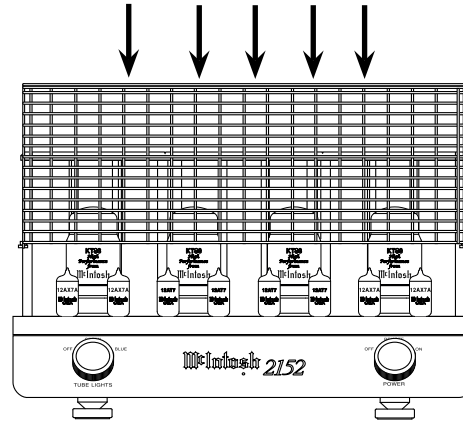

Figure 4D

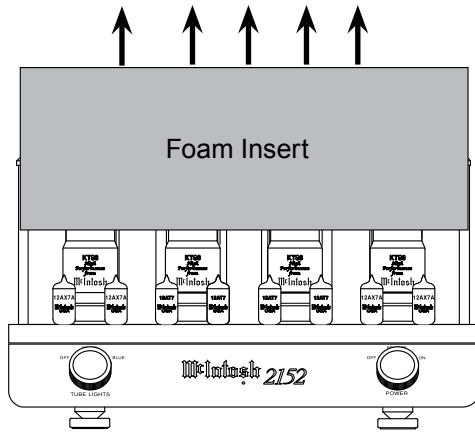

Figure 7G

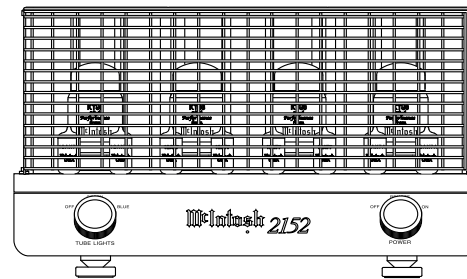

Figure 5E

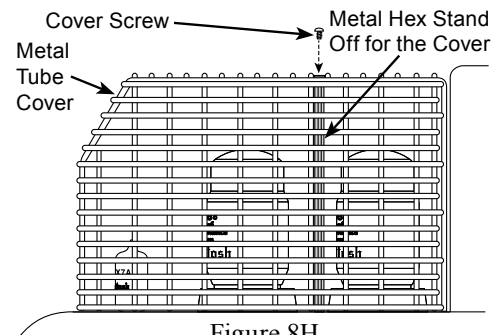
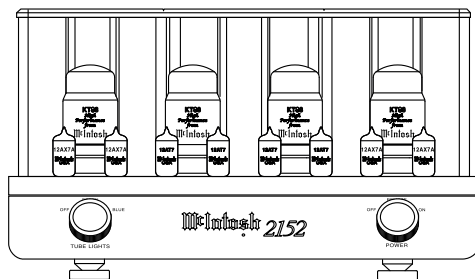

Figure 8H

Ventilation

Adequate ventilation extends the trouble free life of the MC2152. Always allow air to flow through the ventilation holes on the bottom of the amplifier and a means for the warm air to escape at the top. Refer to figure 9.

Allow at least 19 inches (48.3cm) above the top; 6 inches (15.2cm) for the Front, Rear and Sides; allow 1/2 inch (1.3cm) below the Power Amplifier so the airflow is not obstructed.

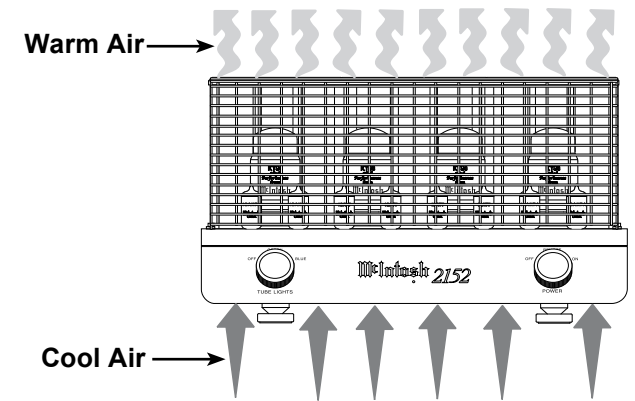

Figure 9



General Information

1. For additional connection information, refer to the owner's manual(s) for any component(s) connected to the MC2152.
2. Apply AC Power to the MC2152 and other McIntosh Component(s) only after all the system components are connected together. Failure to do so may cause a malfunction of system operations as the Microprocessor's Circuitry inside the components is active when AC Power is applied.
3. **The MC2152 includes an Auto Off Power Save Feature and the default setting is enabled.** For additional information including how to disable it, refer to page 13.
4. When Power Amplifier Protection Circuitry of the MC2152 has activated the Small Vacuum LED Illumination and the Front Panel Standby LED Power Indicator will both start flashing. The AC Power to the MC2152 needs to be switched OFF at that time.
5. When the Power Transformer has overheated due to improper ventilation and/or high ambient operating temperature, AC Power is removed from the MC2152.
6. For the best performance and safety, it is important to always match the impedance of the Loudspeaker to the Power Amplifier connections. Refer to pages 10 and 11.

Note: The impedance of a Loudspeaker actually varies as the Loudspeaker reproduces different frequencies. As a result, the nominal impedance rating of the Loudspeaker (usually measured at a midrange frequency) might not always agree with the impedance of the Loudspeaker at low frequencies where the greatest amount of power is required. Contact the Loudspeaker Manufacturer for additional information about the actual impedance of the Loudspeaker before connecting it to the McIntosh MC2152.

7. When discarding the unit, comply with local rules or regulations. Batteries should never be thrown away or incinerated but disposed of in accordance with the local regulations concerning battery disposal.
8. For additional information on the MC2152 and other McIntosh Products please visit the McIntosh Website at www.mcintoshlabs.com.



Connector and Cable Information

XLR Connectors

Below is the Pin configuration for the XLR Balanced Input Connectors on the MC2152. Refer to the diagram for connection:

- PIN 1: Shield/Ground
- PIN 2: + Output
- PIN 3: - Output

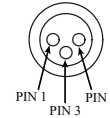

Power Control Connector

The Power Control Output Jack sends Power On/Off Signals (+12 volt/0 volt) when another McIntosh Component is connected. The Power Control Output will in turn provide a +12 volt Output Signal with a current up to 25 mA. An additional connection is for controlling the illumination of the MC2152 Small Signal Tubes when connected to a compatible McIntosh Preamplifier or A/V Control Center Power Control Output. A 3.5mm stereo mini phone plug is used for connection to the Power Control Output.

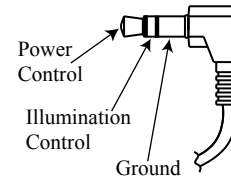

Output Terminal Connector

When cables with spade lugs are used for Loudspeaker Connection, the spade lugs need an opening of at least 3/10 inch (7.6mm)

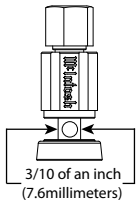

Introduction

Now you can take advantage of traditional McIntosh standards of excellence in the MC2152 Tube Power Amplifier. The 150 watt power output per channel will drive any high quality Loudspeaker System. The MC2152 reproduction is sonically transparent and absolutely accurate. The McIntosh Sound is “The Sound of the Music Itself.”

Performance Features

• Power Output

The MC2152 is a Tube Power Amplifier with a capability of 150 watts per channel into 2, 4 or 8 ohm Loudspeakers with less than 0.5% distortion.

• Unity Coupled Circuitry

The MC2152 Power Amplifier uses the famous McIntosh Patented Unity Coupled Circuit which provides low distortion, extended frequency response and cool operating output tubes.

• Multifilar Wound Output Transformer

The MC2152 Output Transformer Windings are part of the Unity Coupled Circuitry. There are two bifilar wound primaries, one for the cathodes and one for the plates. The secondary winding is wound together with the primary windings. This provides very close primary to secondary coupling. The result is flat frequency response and wide power bandwidth.

• Balanced and Unbalanced Input

Balanced connections guard against induced noise and allow long cable runs without compromising sound quality.

• Sentry Monitor Tube Protection

McIntosh Sentry Monitor Tube Protection Circuits ensure the MC2152 will have a long and trouble free operating life.

• Vacuum Tube Sockets

Small Signal Vacuum Tubes Sockets have Ceramic Base construction with gold plated contacts, providing protection from atmospheric contamination. Output Tube Sockets include Air-Pipe cooling at their bases for long term operation.

• Amplifier Gold Plated Connectors

Gold Plated Input Jacks and Output Binding Posts provide trouble free connections.

• Special Power Supply

A regulated Power Supply, a very large core Power Transformer and large capacitors ensure stable noise free operation even though the power line varies.

• LED Tube Illumination

Tri-Color LEDs illuminate the small signal processing tubes of the MC2152. They indicate tube warm up, normal and sentry monitor modes of operation.

• Special Chassis

The Aluminum Extrusion Heavy Duty Chassis is a Highly Rugged Construction for the very large size of the MC2152 McIntosh Tube Power Amplifier. This type of design will retain the pristine beauty of the MC2152 for many years to come.

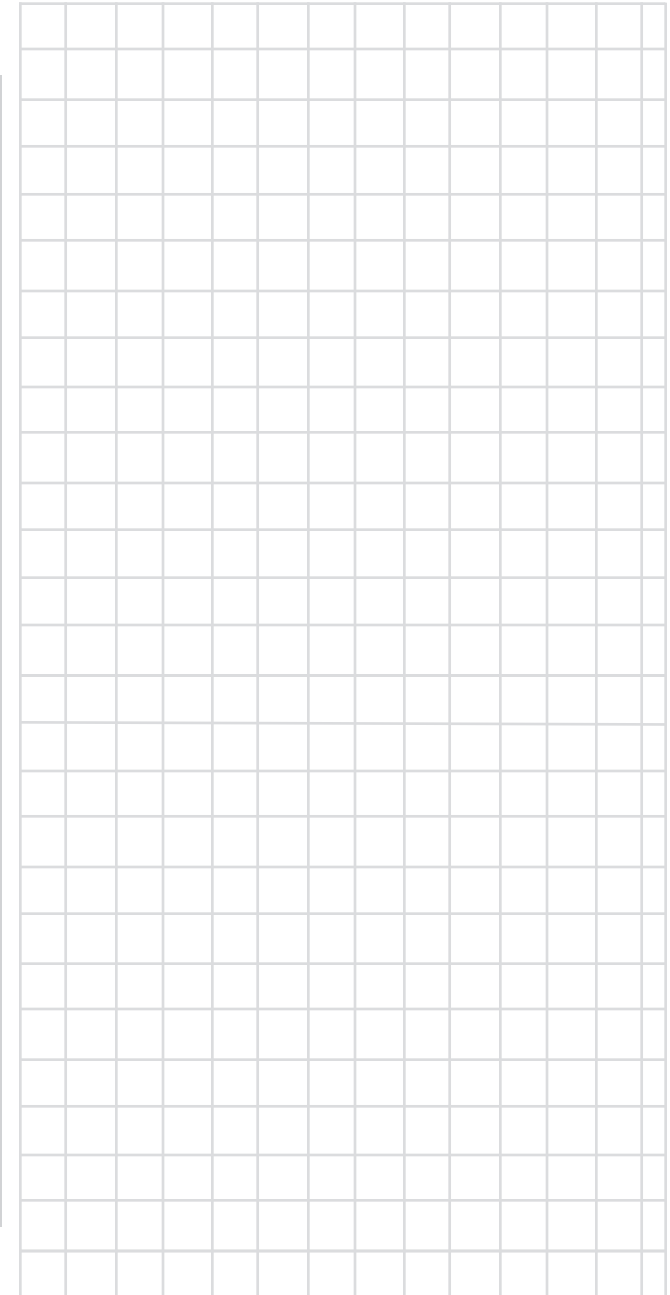



Dimensions

The following dimensions can assist in determining the best location for your MC2152.

Front View of the MC2152

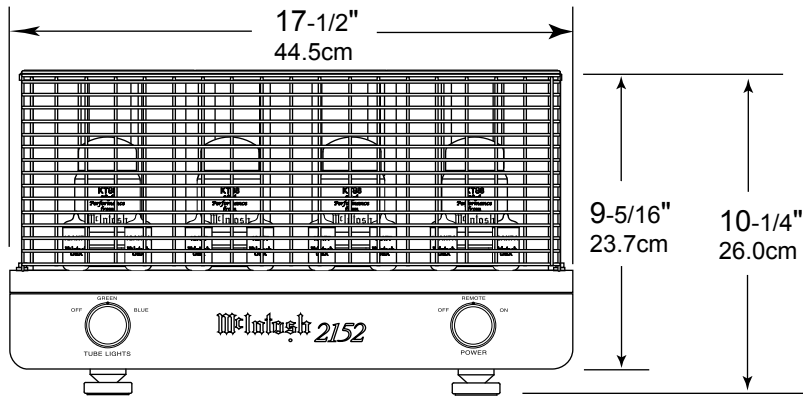

Side View of the MC2152

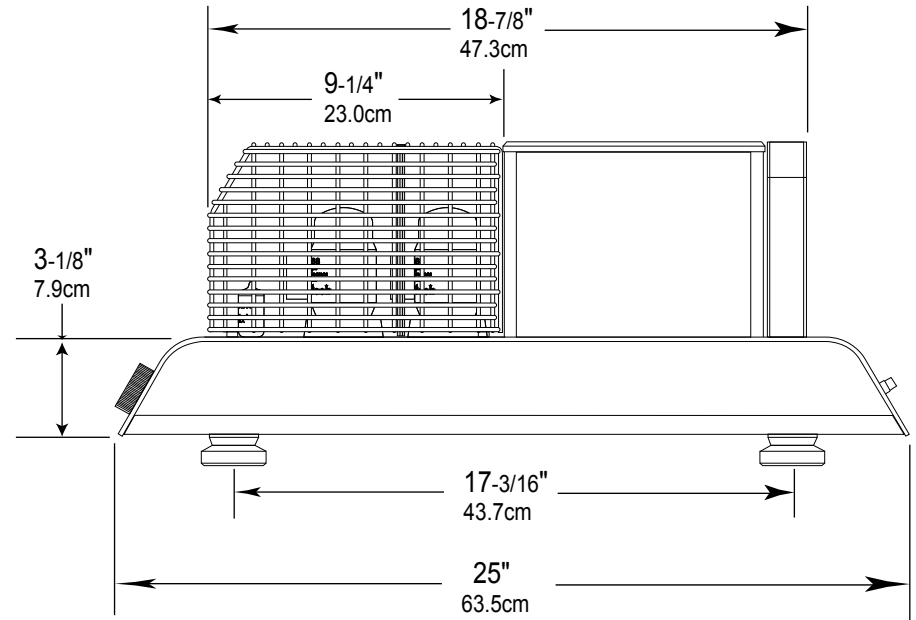

Rear View of the MC2152

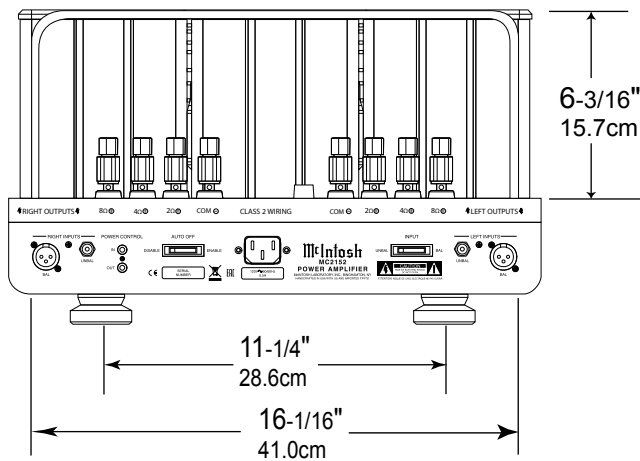

RIGHT OUTPUTS
Connections for a 2, 4 or 8 ohm Loudspeaker

LEFT OUTPUTS
Connections for a 2, 4 or 8 ohm Loudspeaker

Fuse holder, refer to the nomenclature next to the fuse holder to determine the correct fuse size and rating

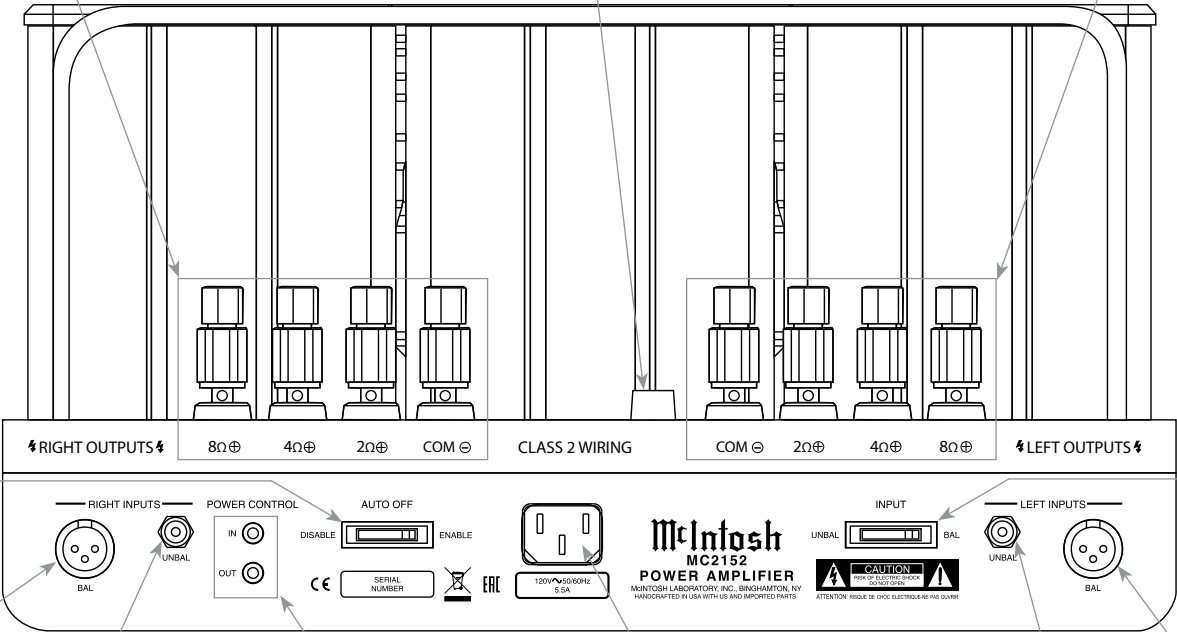

AUTO OFF DIS-ABLE or ENABLE the Power Saving Circuitry

INPUT switch selects between BALANCED and UNBALANCED Input connections

BALANCED RIGHT INPUTS for audio cables from a Preamplifier or A/V Control Center audio output

POWER CONTROL IN receives a turn On/Off signal from a McIntosh component
POWER CONTROL OUT sends a turn On/Off signal to the next McIntosh Component

UNBALANCED LEFT INPUTS for audio cables from a Preamplifier or A/V Control Center audio output

UNBALANCED RIGHT INPUTS for audio cables from a Preamplifier or A/V Control Center audio output

Connect the MC2152 power cord to a live AC outlet. Refer to the nomenclature below this AC Socket to determine the correct voltage

BALANCED LEFT INPUTS for audio cables from a Preamplifier or A/V Control Center audio output



Output Terminals

When connecting the Loudspeaker Hookup Cables to the MC2152 Power Amplifier Output Terminals please follow the steps below:

1. Rotate the top of the Output Terminal Post counterclockwise until an opening appears. Refer to figures A and B.
2. Insert the Loudspeaker hookup cable into the Output Terminal Post opening or the cable spade lug around the center post of the Output Terminal. Refer to figure C.
3. Rotate the top of the Output Terminal Post clockwise until it is finger tight. Refer to figure D.
4. Place the supplied McIntosh Wrench over the top of the Output Terminal and rotate it one quarter of a turn (90°) to secure the Loudspeaker Cable Connection. **Do not over tighten.** Refer to figure E.

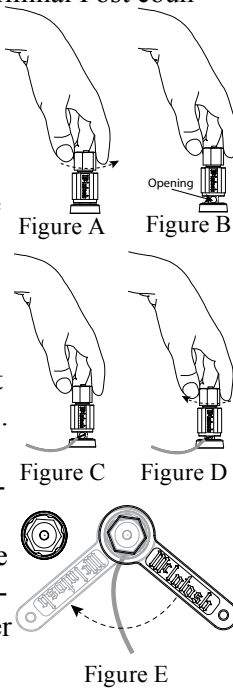

How to Connect for Stereo Operation

Caution: Do not connect the AC Power Cord to the MC2152 Rear Panel until after the Loudspeaker Connections are made. Failure to observe this could result in Electric Shock.

The connection instructions below, together with the MC2152 Connection Diagram located on the separate folded sheet “Mc1A”, is an example of a typical audio system. Your system may vary from this, however the actual components would be connected in a similar manner. For additional information refer to “Connector and Cable Information” on page 6.

1. For Remote Power Control, connect a power control cable from the Audio Preamplifier Power Control Main Output Jack to the Power Amplifier POWER CONTROL IN Jack.
2. Connect XLR cables from the Balanced Main Output connector of the Audio Preamplifier to the Power Amplifier BALANCED INPUTS. Place the INPUT Switch in the BALANCED Position.

Note: An optional hookup is to use unbalanced cable and place the INPUT MODE Switch in the UNBALANCED Position.

This McIntosh MC2152 Power Amplifier is designed for Loudspeakers with an impedance of 2 ohms, 4 ohms or 8 ohms. Connect a single Loudspeaker only to the Output Terminals.

When connecting Loudspeakers to the MC2152 it is very important to use cables of adequate size, so there is little to no power loss in the cables. The size is specified in Gauge Numbers or AWG (American Wire Gauge). The smaller the Gauge number, the larger the wire size:

Loudspeaker Cable Distance vs Wire Gauge Guide			
Loudspeaker Impedance	25 feet (7.62 meters) or less	50 feet (15.24 meters) or less	100 feet (30.48 meters) or less
2 Ohms	12AWG	10AWG	8AWG
4 Ohms	14AWG	12AWG	10AWG
8 Ohms	16AWG	14AWG	12AWG

3. Prepare the Loudspeaker Hookup Cable for attachment to the MC2152 Power Amplifier:

Bare wire cable ends:

Carefully remove sufficient insulation from the cable ends, refer to figures 1, 2 & 3. If the cable is stranded, carefully twist the strands together as tightly as possible.

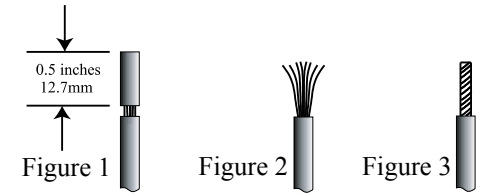

- Notes:*
1. If desired, the twisted ends can be tinned with solder to keep the strands together.
 2. The prepared bare wire cable ends may be inserted into spade lug connectors.
 3. Banana plugs are for use in the United States and Canada only.

Banana Plugs are for use in the United States and Canada only:

4. Attach the previously prepared bare wire cable ends into the banana plugs and secure the connections. Refer to figure F.
5. Rotate the top of the Output Terminal Post clockwise until it is finger tight. Refer to figure G. Then using the McIntosh Wrench, rotate the top of the Output Terminal one quarter of a turn (90°). **Do not over tighten.** Refer to figure E.
6. Referring to figure H, connect the Loudspeaker hookup cables with banana plugs into the hole at the top of the MC2152 Negative (-) and Positive (+) Output Terminals. The Positive Terminals are identified as 4Ω (ohms), 8Ω (ohms) or 16Ω

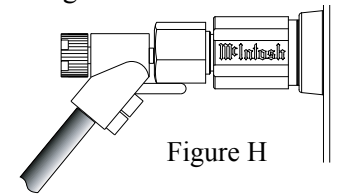
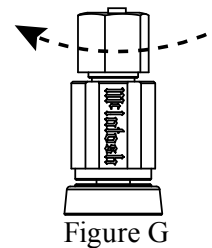
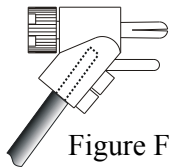

(ohms) connection to match the impedance of the Loudspeaker, being careful to observe the correct polarities.

If the Loudspeaker's impedance is in-between the available connections, use the nearest lower impedance connection. Refer to "General Information" Note 6 on page 6 for additional information.

WARNING: Loudspeaker Terminals are hazardous live and present a risk of electric shock. For additional instruction on making Loudspeaker Connections contact your McIntosh Dealer or McIntosh Technical Support.

7. Connect the MC2152 Power Cord to an active AC outlet.

Spade Lug or Wire Connections:

8. Connect the Loudspeaker hookup cables to the MC2152 Negative Output Terminal (-) and Positive Output (+) Terminal identified as 2Ω (ohms), 4Ω (ohms) or 8Ω (ohms) connection to match the impedance of the Loudspeaker, being careful to observe the correct polarities. Insert the spade lug connector or prepared section of the cable end into the terminal side access hole, and tighten the terminal cap until the cable is firmly clamped into the terminals so the lugs or wire cannot slip out. **Do not over tighten.** Refer to figures 4, 5 and figure E.

Note: Refer to "Output Terminal" step 4 on page 10 for important information.

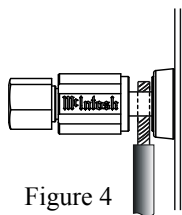

Figure 4

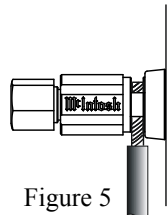
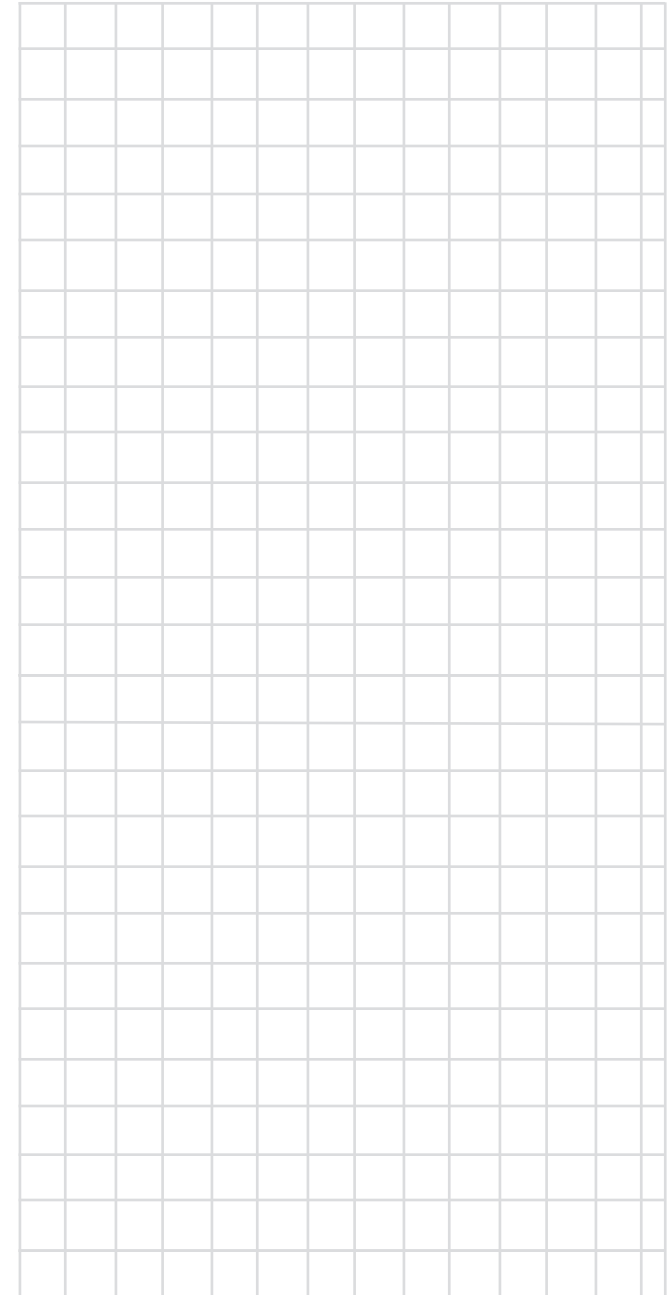

Figure 5

If the Loudspeaker's impedance is in-between the available connections, use the nearest lower impedance connection. Refer to "General Information" Note 6 on page 6 for additional information.

WARNING: Loudspeaker terminals are hazardous live and present a risk of electric shock. For additional instruction on making Loudspeaker Connections contact your McIntosh Dealer or McIntosh Technical Support.

9. Connect the MC2152 Power Cord to an active AC outlet.



Left Channel Small Signal Vacuum Tubes

LED Illumination Color	Operation Mode	Function
Amber	Warm-up	Audio Signal is muted
Green or Blue	Normal	Selected by Tube Light Control
Red (Flash Illumination)	Sentry	Protection Circuitry is Activated

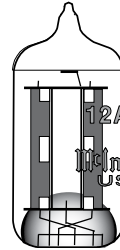

Right Channel Small Signal Vacuum Tubes

LED Illumination Color	Operation Mode	Function
Amber	Warm-up	Audio Signal is muted
Green or Blue	Normal	Selected by Tube Light Control
Red (Flash Illumination)	Sentry	Protection Circuitry is Activated

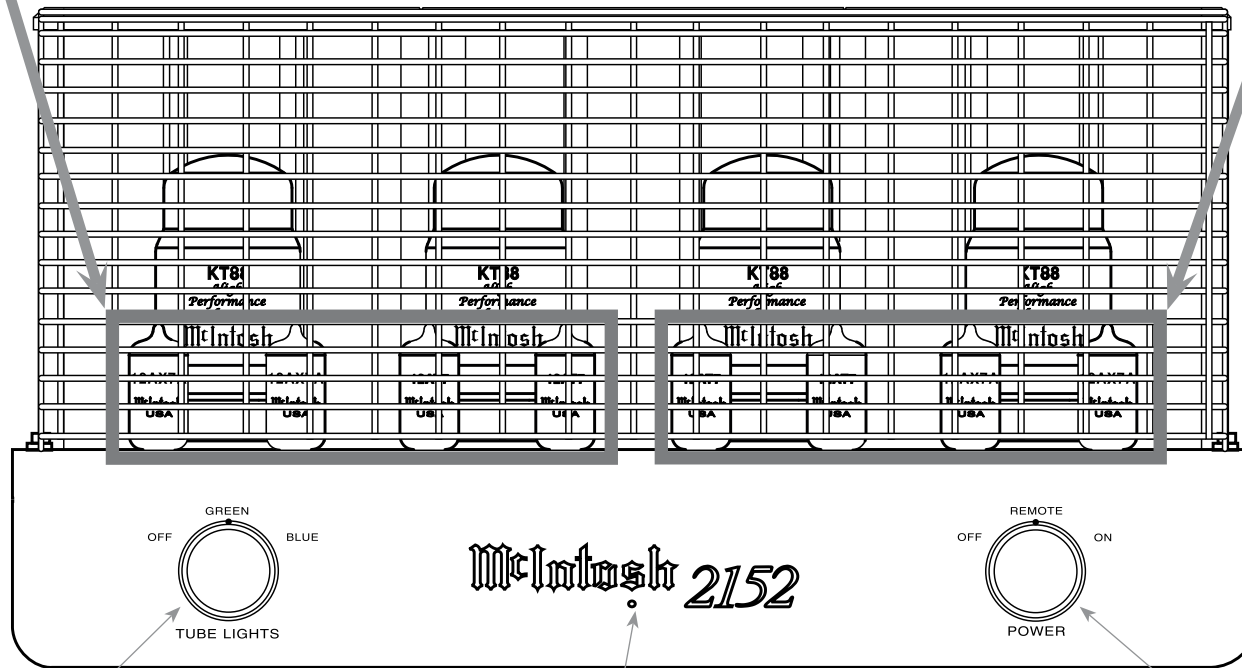

TUBE LIGHTS select the active LED Color

Standby Power On Indicator

POWER Switch Turns AC Power ON, or OFF/REMOTE

How to Operate

Power Control

The POWER CONTROL is located on the Front Panel of the MC2152, set the Control to the REMOTE Position. Refer to figure 10. The MC2152 Power Amplifier will turn ON or OFF as the Preamplifier it is connected to (via the Power Control Connection) turns

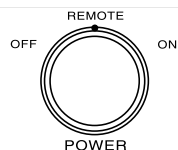

Figure 10

On or Off. For manual operation, place the POWER CONTROL to the ON Position as desired. The LED indicator located on the Front Panel below the “McIntosh” Name is illuminated when the MC2152 is connected to an active AC Outlet. Refer to figure 11.



Figure 11

Note: When the MC2152 is first switched On, there is a Warm-Up period of time during which no sound will be heard. There is also sequential illumination (amber color) of the Small Signal Vacuum Tubes. After the Warm-Up period of time, sound will be heard and the illumination color of the Small Signal Vacuum Tubes will change to either Green or Blue as were previously selected. The Illumination of Small Signal Vacuum Tubes can also be switched OFF, by placing the TUBE LIGHT Control in the OFF position.

Tube Lights Control

The eight Small Signal Vacuum Tubes are Illuminated by LEDs to indicate the various Operation Modes of the MC2152 Power Amplifier. Refer to the Left and Right Channel Charts located on page 12. When the MC2152 Power Amplifier is in the Normal Mode of Operation, the default LED Illuminating Color is Green in color. Rotating the TUBE LIGHTS CONTROL clockwise will change the LED

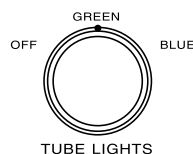

Figure 12

clockwise will change the LED

Illuminating Color from Green to Blue. Refer to figure 12.

Input Switch

The Input Mode Switch, which is located on the Rear Panel of the MC2152, allows selection of either the Balanced or Unbalanced Input. Refer to figure 13.

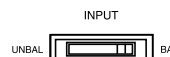

Figure 13

Auto Off Switch

The MC2152 incorporates Power Save Circuitry to automatically place the MC2152 into the power saving Standby Mode approximately 30 minutes after there has been an absence of an audio input signal.

When there is a Power Control Connection between the MC2152 and a Preamplifier with Power Save Circuitry, the AUTO OFF Switch is bypassed (located on the Rear Panel of the MC2152). Refer to figure 14.



Figure 14

In the event there is no Power Control Connection and the Power Save Circuitry is activating inappropriately relative to your specific use of the MC2152, place the AUTO OFF Switch in the DISABLE position.

Note: If the Power Save Circuitry has switched Power to the MC2152 OFF, place the POWER in the OFF Position and then in the ON position to reset the circuitry.

Sentry Monitor

The MC2152 Sentry Monitor Tube Protection Circuitry provides protection to the Power Amplifier in the event of an impedance mismatch between the MC2152 and the Loudspeaker(s). It will also activate if there is a short circuit at the MC2152 Output Terminals (or the Loudspeaker Terminals) or if a MC2152 Power Output

Tube should fail. During normal operation the Sentry Monitor Tube Protection Circuitry has no effect on the performance of the Power Amplifier.

In the event a problem occurs, the circuitry will activate to prevent potentially destructive high levels of current from flowing in the amplifier. The illumination color of the Small Signal Vacuum Tubes of the affected channel will change from Green or Blue to Red. To reset the Sentry Monitor Tube Protection Circuitry first note the position of the POWER Switch. If the POWER Switch is set to the REMOTE position, switch Off the Preamplifier for approximately one minute and then switch the Preamplifier On. When the POWER Switch set to the ON position, place the POWER Switch to the OFF position for approximately one minute, then place the POWER Switch to the ON position.

Notes: 1. The impedance of a Loudspeaker actually varies as the Loudspeaker reproduces different frequencies. As a result, the nominal impedance rating of the Loudspeaker (usually measured at a midrange frequency) might not always agree with the impedance of the Loudspeaker at low frequencies where the greatest amount of power is required. Contact the Loudspeaker Manufacturer for additional information about the actual impedance of the Loudspeaker before connecting it to the McIntosh MC2152.

2. When the given channel doesn't return to Normal Operating after the Power Switch has been switched back ON, then place the Power Switch in the OFF position and disconnect the AC Power Cord from the MC2152. Then contact your McIntosh Dealer for repair of the Power Amplifier.



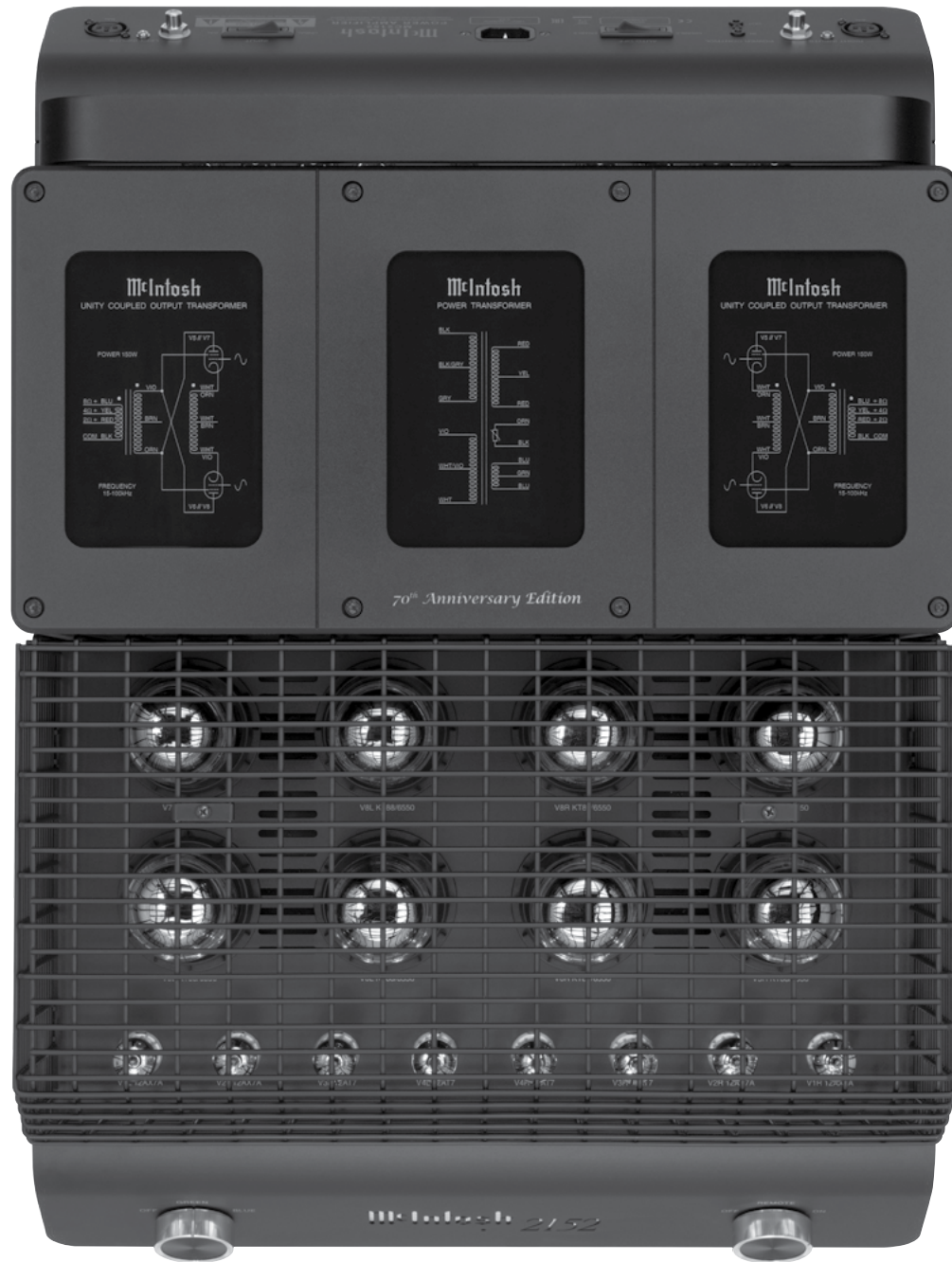



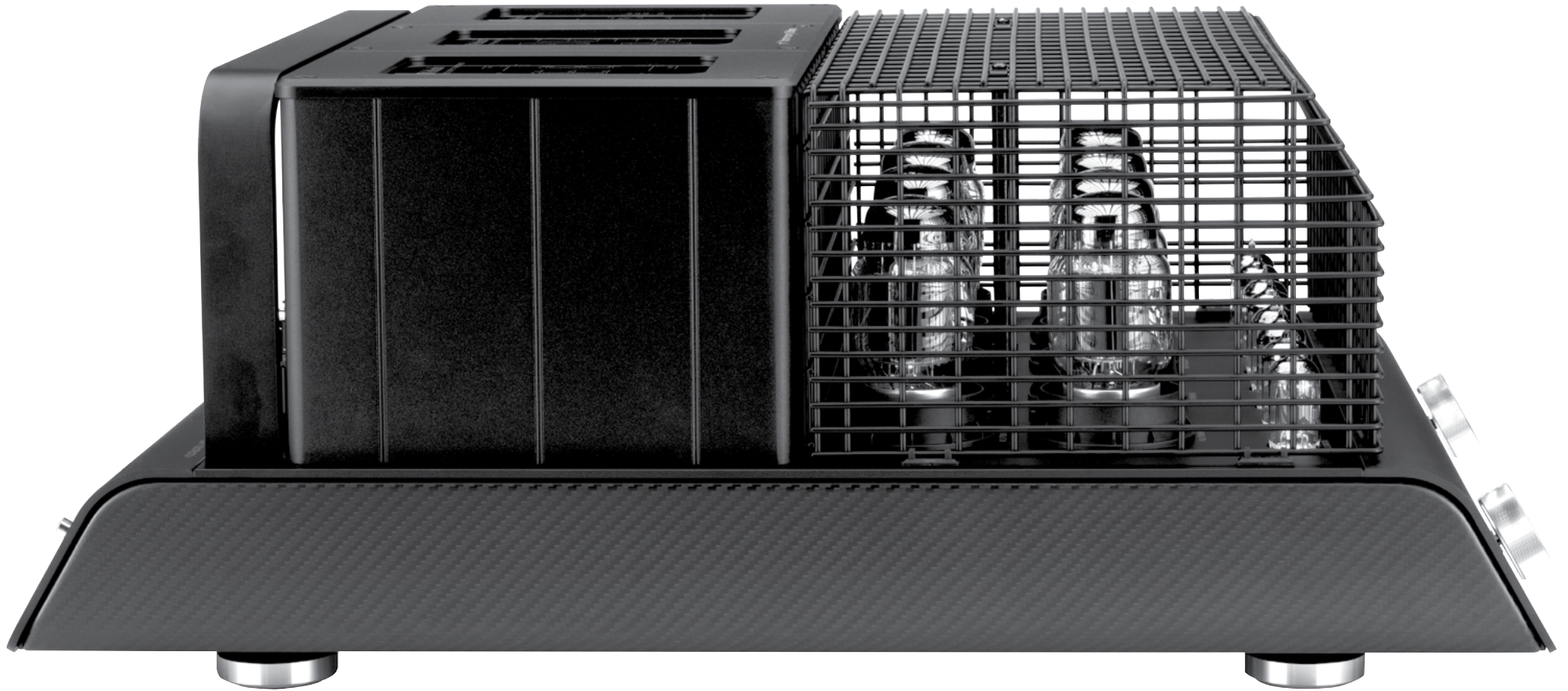



Specifications

Power Output

Minimum sine wave continuous average power output per channel, both channels operating is:

- 150 watts into 2 ohm loads
- 150 watts into 4 ohm loads
- 150 watts into 8 ohm loads

Output Load Impedance

2, 4 or 8 ohms

Rated Power Band

20Hz to 20,000Hz

Total Harmonic Distortion

0.5% maximum harmonic distortion at any power level from 250 milliwatts to rated power, 20Hz to 20,000Hz

Dynamic Headroom

1.2dB

Frequency Response

- +0, -0.5dB from 20Hz to 20,000Hz
- +0, -3.0dB from 10Hz to 70,000Hz

Input Sensitivity (for rated output)

- 1.7 Volts Unbalanced
- 3.4 Volts Balanced

Signal To Noise Ratio (A-Weighted)

112dB below rated output

Intermodulation Distortion

0.5% maximum, if the instantaneous peak power output does not exceed twice the rated power output for any combination of frequencies from 20Hz to 20,000Hz.

Wide Band Damping Factor

Greater than 18

Input Impedance

- 47,000 ohms Unbalanced
- 20,000 ohms Balanced

Power Control Input

5-15VDC, less than 1mA

Power Control Output

- 12VDC, 25mA
- Output is delayed 0.2 seconds from turn On.

Tube Compliment

- 4 - 12AX7A Input and Phase Inverter
- 4 - 12AT7 Voltage Amplifier and Driver
- 8 - KT88/6550 Power Output

Power Requirements

Field AC Voltage conversion of the MC2152 is not possible. The MC2152 is factory configured for one of the following AC Voltages:

- 100V ~ 50/60Hz at 6.6 Amps
- 110V ~ 50/60Hz at 6.0 Amps
- 120V ~ 50/60Hz at 5.5 Amps
- 127V ~ 50/60Hz at 5.5 Amps
- 220V ~ 50/60Hz at 3.0 Amps
- 230V ~ 50/60Hz at 2.75 Amps
- 240V ~ 50/60Hz at 2.75 Amps
- Standby: Less than 0.3 watts

Note: Refer to the right side panel of the MC2152 for the correct voltage.

Overall Dimensions

- Width is 17-1/2 inches (44.5cm)
- Height is 10-1/4 inches (26.0cm) including feet
- Depth is 28 inches (71.1cm) including Cables

Weight

125 pounds (56.7 kg) net, 138 pounds (62.6 kg) in shipping carton

Shipping Carton Dimensions

- Width is 24 inches (61.0cm)
- Height is 14 inches (35.6cm)
- Depth is 30-1/2 inches (77.5cm)

Packing Instructions

In the event it is necessary to repack the equipment for shipment, the equipment must be packed exactly as shown below. It is very important that the four feet are attached to the bottom of the equipment. This will ensure the proper equipment location on the bottom foam pad. Failure to do this will result in shipping damage.

To protect the tubes during shipment, the Foam Insert removed from the MC2152 needs to be re-inserted. Follow the unpacking instructions on pages 4-5 in the reverse order.

Use the original shipping carton and interior parts only if they are all in good serviceable condition. If a shipping carton or any of the interior part(s) are needed, please call or write Customer Service Department of McIntosh Laboratory, refer to page 2. Please see the Part List for the correct part numbers.

Quantity	Part Number	Description
1	034599	Shipping Carton Top
1	034608	Shipping Carton Bottom
1	034600	Foam Tube (for protecting the Tubes during shipping)
1	034601	Foam End Cap Top
1	034602	Foam End Cap Bottom
1	034609	Foam Ring
1	041893	Warning Sheet
4	400159	10-32 x 3/4 inch screw
4	218085	Feet

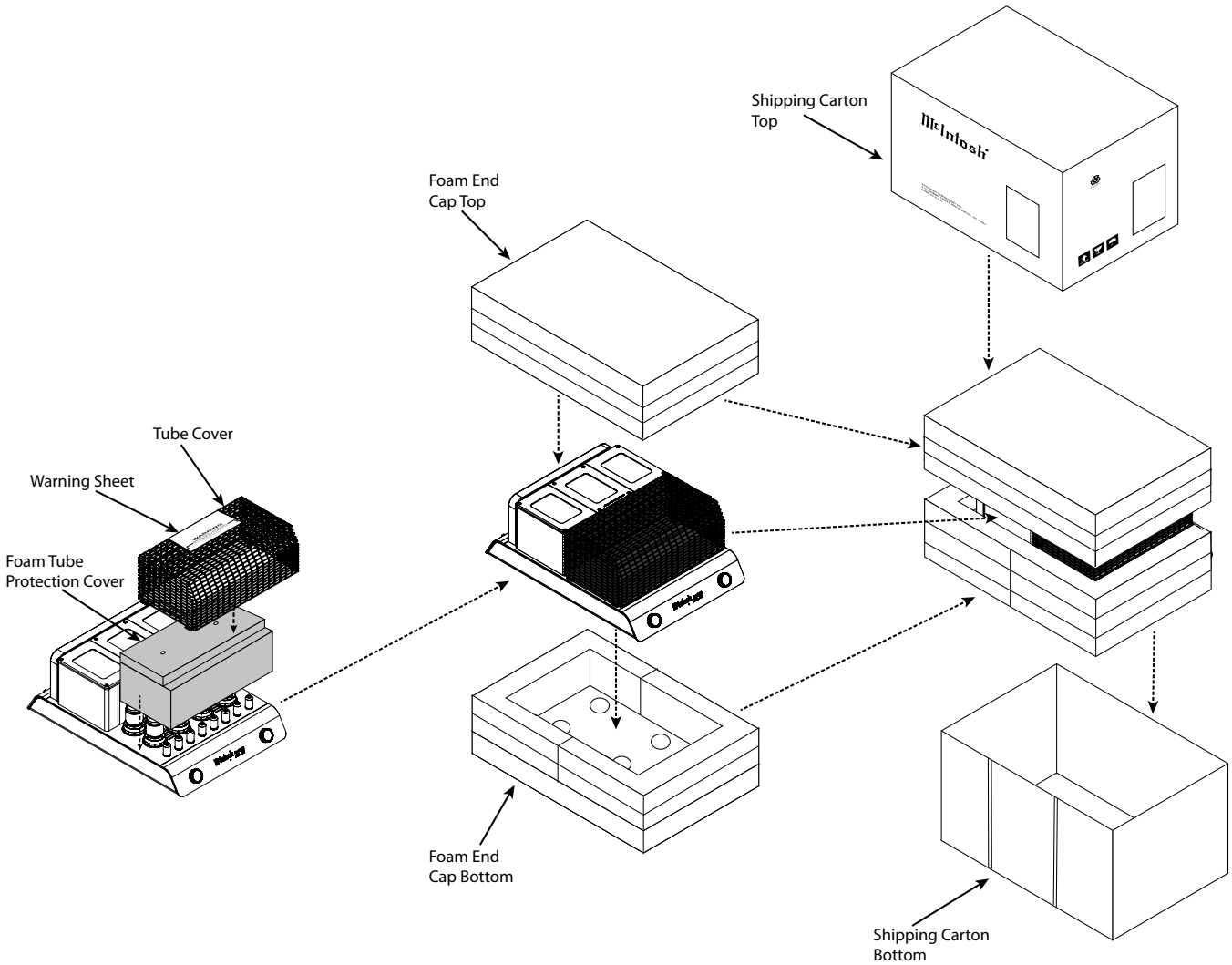



McIntosh Laboratory, Inc.
2 Chambers Street
Binghamton, NY 13903
www.mcintoshlabs.com

The continuous improvement of its products is the policy of McIntosh Laboratory Incorporated who reserve the right to improve design without notice.
Printed in the U.S.A.